

Accessories

Trumpf



1	Standard Accessories	3
1.1	Clamps and side rails	3
1.2	Anaesthesia	5
1.3	HOLDERS and trays	7
1.4	Patient fixation	9
1.5	Arm and leg support	11
1.6	Head Positioning	16
1.7	Supports	20
2	Carbon and Accessories	24
3	Gynaecology/ Urology	30
4	Neurosurgery	34
5	Spine surgery	36
6	Orthopaedics/ Traumatology	42
6.1	Standard Accessories Orthopedics	42
6.2	Plaster Accessories	46
7	Extension	49
7.1	Extension - New Generation	50
7.2	Extension MARS/SATURN	55
7.3	Extension Accessories	58
8	Pediatric Surgery	62
9	Bariatric Surgery	65
10	Positioning Devices	71
10.1	Positioning Pads	71
10.2	Vacuum mattresses	73
10.3	Gel pads	74
11	Medical furniture	75
	Numerical Product Chart	77
	General Terms and Conditions	80

Delivery is made exworks.

All deliveries are subject to our effective General Terms and Conditions.

Errors are excepted and the right to make changes is reserved.

This publication of price list renders all previous price lists invalid.

The mentioned prices are only a basis for the accounting with the trade and not recommended trade prices.

All prices are quoted without sales tax.

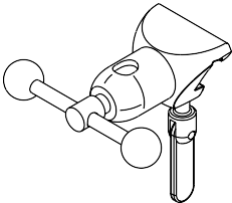
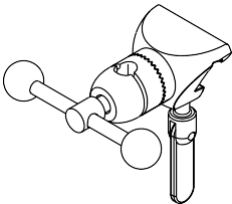
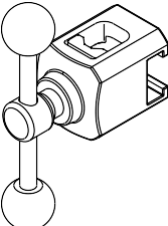
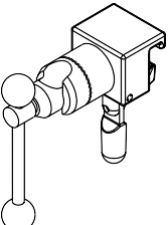
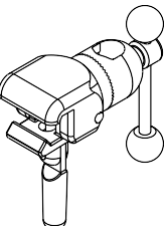
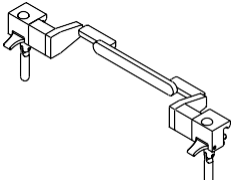

1 Standard Accessories

1.1 Clamps and side rails

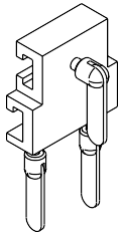
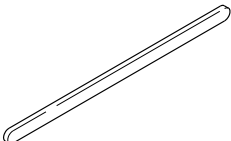
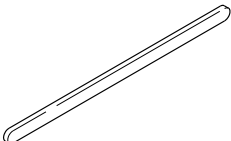
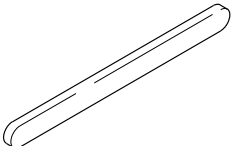
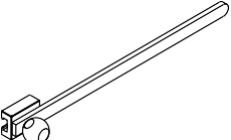
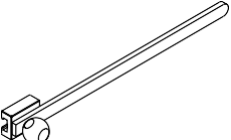
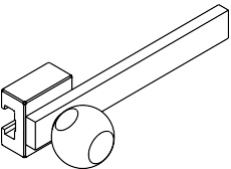
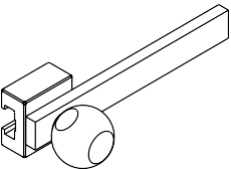
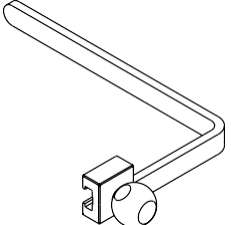
	Description	Material-No
	Y-clamp to attach to side rail by frontal placement; suitable for rods 14 mm - 18 mm in diameter; stainless steel	4544701
	Y-clamp radial setting to attach to side rails by frontal placement; 360° adjustment; suitable for rods 14 mm - 18 mm in diameter; stainless steel	4544700
	Clamp basic to attach to side rails; suitable for rods 16 mm - 20 mm in diameter; stainless steel	1305173
	Clamp radial setting to attach to side rails by frontal placement; for heavy loads; 360° adjustment; suitable for rods 15 mm - 18 mm in diameter; stainless steel	1218804
	Radial setting clamp HEAVY version for heavy loads; to attach to side rails by frontal placement; 360° adjustment; suitable for rods of 15 mm - 20 mm diameter; stainless steel	4544530
	Side rail with clamp to attach to Trumpf Medical coupling point system; stainless steel dimensions side rail: 25 mm x 10 mm	4544792

	Description	Material-No
	<p>Side rail adapter stainless steel dimensions side rail: 25 mm x 10 mm</p>	<p>4544165</p>
	<p>Side rail stainless steel; length: 520 mm dimensions side rail: 25 mm x 10 mm</p>	<p>4544166</p>
	<p>Side rail U stainless steel; length: 520 mm dimensions side rail: 28.6 mm x 9.5 mm</p>	<p>4500166</p>
	<p>Side rail short stainless steel; length: 300 mm dimensions side rail: 25 mm x 10 mm</p>	<p>1317780</p>
	<p>Side rail extension with clamp; stainless steel; length 520 mm dimensions side rail: 25 mm x 10 mm</p>	<p>1218646</p>
	<p>Side rail extension U with clamp; stainless steel; length: 520 mm dimensions side rail: 28.6 mm x 9.5 mm</p>	<p>4501001</p>
	<p>Side rail extension 160 with clamp; stainless steel; total length: 200 mm length of side rail: 60 mm dimensions side rail: 25 mm x 10 mm</p>	<p>1309436</p>
	<p>Side rail extension 160 U with clamp; stainless steel; total length: 200 mm length of side rail: 160 mm dimensions side rail: 28.6 mm x 9.5 mm</p>	<p>1345696</p>
	<p>Side rail extension angled 90° with clamp; stainless steel dimensions side rail: 25 mm x 10 mm</p>	<p>1218872</p>

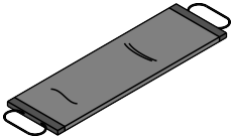
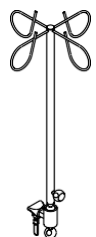
1.2 Anaesthesia

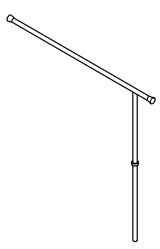
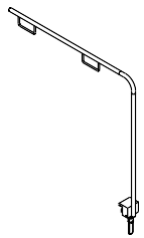
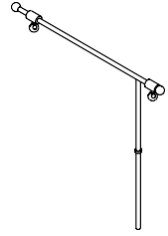
	Description	Material-No
	<p>Rollboard foldable dimensions (LxWxH): 1770 mm x 500 mm (by Transatlantic Handelsgesellschaft)</p>	<p>4545675</p>
	<p>Infusion pole with 4 hooks with clamp; to attach to side rails by frontal placement; with ball joint; height adjustable; stainless steel; height adjustment: 620 mm</p>	<p>4544708</p>
	<p>Clamp for tubing holder for tubing holder 1403003; to attach to side rails (by Teleflex Medical GmbH)</p>	<p>1606992</p>
	<p>Tubing holder for attaching resuscitation tubes and monitor cables (by Teleflex Medical GmbH)</p>	<p>1403003</p>
	<p>Anaesthesia screen without clamp; to attach to side rails; electrically insulated plus a safety ring; height adjustable via clamp; stainless steel; vertical rod diameter: 16 mm height adjustment: 500 mm</p>	<p>1218820</p>
	<p>Anaesthesia screen basic with clamp; to attach to side rails by frontal placement; stainless steel</p>	<p>4544713</p>
	<p>Anaesthesia screen extendable without clamp; to attach to side rails; two rods with lateral extension; electrically insulated plus a safety ring; height adjustable via clamp; stainless steel; vertical rod diameter: 18 mm height adjustment: 500 mm</p>	<p>4544710</p>

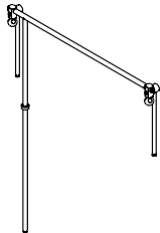
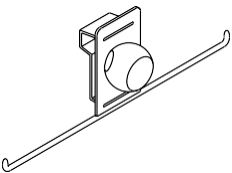
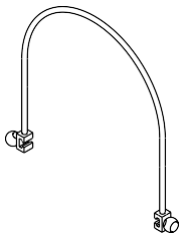
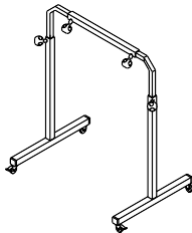
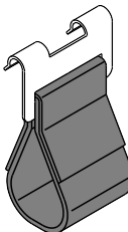
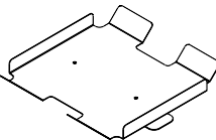
	Description	Material-No
	<p>Anaesthesia screen with elongation without clamp; to attach to side rails; electrically insulated plus a safety ring; height adjustable via clamp; with rotatable elongations; stainless steel; vertical rod diameter: 16 mm elongation: 300 mm height adjustment: 500 mm</p>	<p>1294003</p>
	<p>Holder for anaesthesia accessories to attach to anaesthesia screen; for securing supply hoses and measuring cables; stainless steel</p>	<p>4544712</p>
	<p>Anaesthesia screen flexible with clamps; to attach to side rails</p>	<p>1218858</p>
	<p>Anaesthesia screen mobile adjustable in height and width; stainless steel; height: 1130 mm - 2000 mm width: 1500 mm - 2000 mm</p> <p>1</p>	<p>4544009</p>
	<p>Suspended arm strap to attach to anaesthesia screens with crossbars up to 22 mm in diameter; resistant to disinfectants and washable; black polyester Velcro strap; stainless steel holding plate; strap width: 100 mm</p>	<p>4544703</p>
	<p>Document tray to attach to shuttle frame; stainless steel</p>	<p>1665990</p>

1.3 Holders and trays

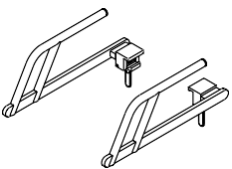
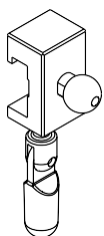
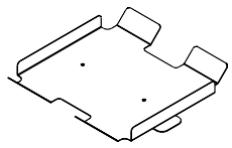
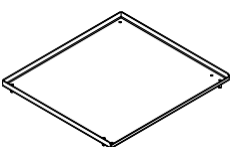
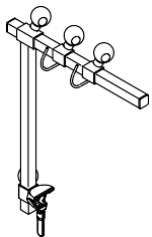
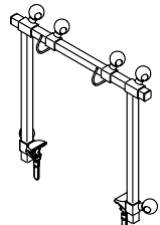
	Description	Material-No
	Handles for operating tables to attach to side rails; enables easier transport of operating tables or an operating table top on a shuttle; stainless steel	1321641
	Holder remote control to attach to side rails; for mounting remote controls; stainless steel	1351241
	Document tray to attach to shuttle frame; stainless steel	1665990
	Instrument tray suitable for all drainage bowl adapters; stainless steel; dimensions (LxWxH): 353 mm x 323 mm x 32 mm	1286562
	Holding bar basic with clamp; with 2 hooks; for surgical utilities; stainless steel; maximum load: 10 kg; height adjustment: 480 mm	4544758
	Holding bar with clamp; with 2 hooks; for surgical utilities; stainless steel; maximum load: 20 kg; height adjustment: 480 mm	4544759

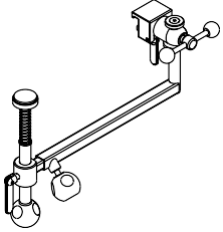
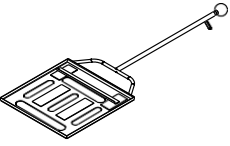
	Description	Material-No
	<p>X-ray cassette holder COMFORT with clamp, for taking vertical X-rays; rotation via swivel joint; lateral adjustment; stainless steel; lateral adjustment: 390 mm - 620 mm height adjustment: 65 mm rotation angle: 360° maximum weight of X-ray cassettes: 3 kg</p>	<p>1305492</p>
	<p>Positioner for X-ray cassettes for X-ray cassettes with maximum dimensions of 380 mm x 380 mm; stainless steel</p>	<p>1256558</p>

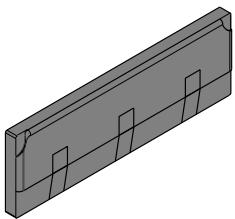
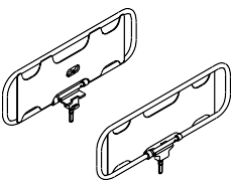
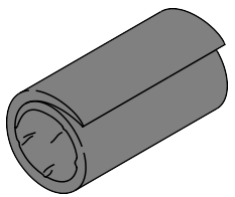
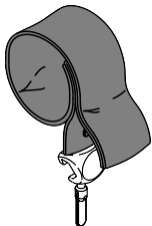
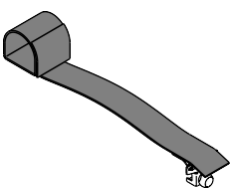
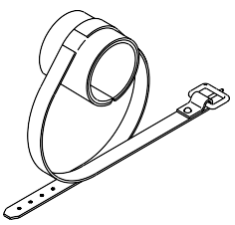

1.4 Patient fixation

	Description	Material-No
	<p>Pad for side guard to attach to 4544434 side guard pair; two pieces are recommended; provides better patient arm protection</p>	<p>1479197</p>
	<p>Side guard pair with clamp; fold-away and detachable; stainless steel; dimensions (LxW): 720 mm x 265 mm</p>	<p>4544434</p>
	<p>Pad cuff to fixate the patient's arm in combination with 1346755 universal and hand cuff; pad electrically conductive and soft; length: 350 mm</p>	<p>1358558</p>
	<p>Universal and hand cuff to attach to side rails by frontal placement; Velcro fastening system provides wide range of adjustment for arm width; resistant to disinfectants and washable; black polyester strap; stainless steel load-bearing structure; strap width: 100 mm</p>	<p>1346755</p>
	<p>Arm safety strap with locking clamp to attach to side rail; Velcro fastening system provides wide range of adjustment for arm width; resistant to disinfectants and washable; black polyester strap; stainless steel clamp; strap width: 100 mm</p>	<p>4544705</p>
	<p>Leg restraint single fixation strap with padded leather</p>	<p>1218828</p>

	Description	Material-No
	Leg restraint two parts fixation strap with padded leather	1218829
	Belt for bariatric surgery pair pair; belt for fixation of the patient's legs in bariatric surgery; dimensions (LxWxH): 1520 mm x 425 mm x 5 mm (per belt) (by Simonsen & Weel)	1783309
	Body strap with locking clamps to attach to side rail; Velcro fastening system provides wide range of adjustment for abdominal girth; resistant to disinfectants and washable; black polyester strap; stainless steel locking clamp; dimensions (LxW): 1800 mm x 100 mm	4544702
	Body strap rotatable to attach to side rail; Velcro fastening system provides wide range of adjustment for abdominal girth; resistant to disinfectants and washable; black polyester strap; stainless steel locking clamp; dimensions (LxW): 1800 mm x 100 mm	4544706
	Belt for patients X-TRA to fixate the patient; black polyester strap; dimensions (LxW): 1700 mm x 50 mm	1582709

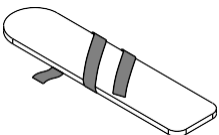
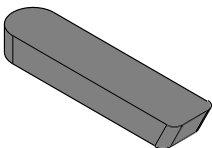
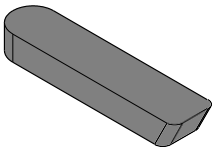
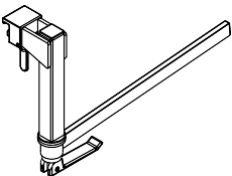
1.5 Arm and leg support

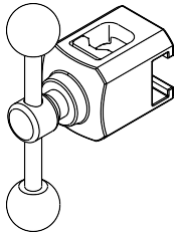
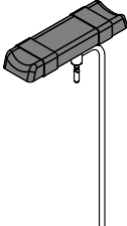
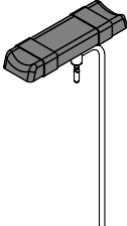
	Description	Material-No
	<p>Arm support with trigger with integrated rapid lock clamp; to attach to side rails (25 mm x 10 mm) by frontal placement; with trigger design for rotation; transparent to X-rays; dimension (LxW): 660 x 140 mm (by Allen Amatech)</p>	<p>2013862</p>
	<p>Arm support with trigger U with integrated rapid lock clamp; to attach to side rails (28.6 mm x 9.5 mm) by frontal placement; with trigger design for rotation; transparent to X-rays; dimension (LxW): 660 x 140 mm (by Allen Amatech)</p>	<p>2013863</p>
	<p>Arm support with trigger J with integrated rapid lock clamp; to attach to side rails (35 mm x 9 mm) by frontal placement; with trigger design for rotation; transparent to X-rays; dimension (LxW): 660 x 140 mm (by Allen Amatech)</p>	<p>2013864</p>
	<p>Flat pad for arm support with trigger can be attached to all types of arm supports with trigger; with viscous elastic pad for decubitus prophylaxis; soft and detachable; with Velcro; dimensions (LxWxH) 660 mm x 140 mm x 50 mm (by Allen Amatech)</p>	<p>2023370</p>
	<p>Pad arm support with trigger can be attached to all types of arm supports with trigger; with viscous elastic pad for decubitus prophylaxis; soft and detachable; with Velcro; dimensions (LxWxH): 660 mm x 140 mm x 90 mm (by Allen Amatech)</p>	<p>2013865</p>
	<p>Holding device for arm and leg with clamp; to hold Arm support pad and Arm holder for lateral position; stainless steel; dimensions side rail: 25 mm x 10 mm</p>	<p>1317577</p>

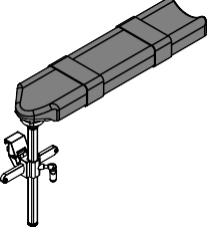

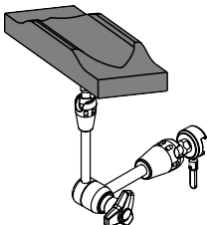
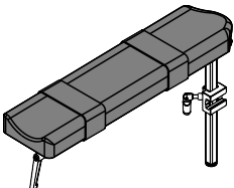
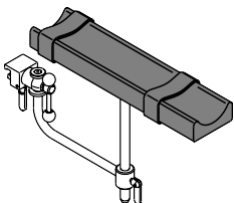
	Description	Material-No
	<p>Clamp basic to attach to side rails; suitable for 16 mm - 20 mm in diameter; stainless steel</p>	<p>1305173</p>
	<p>Arm support pad 450 without clamp; Comfort Plus pad integrally foamed, electrically conductive, soft and detachable; with black polyester Velcro straps; stainless steel load-bearing structure; pad (LxW): 450 mm x 130 mm</p>	<p>1341443</p>
	<p>Arm support pad 450 T without clamp; viscous elastic FoamLine pads used for decubitus prophylaxis, electrically conductive, soft and detachable, with Velcro strap; with black polyester Velcro straps; stainless steel load-bearing structure; pad (LxW): 470 mm x 135 mm</p>	<p>1483383</p>
	<p>Arm holder 450 for lateral position without clamp; Comfort Plus pad integrally foamed, electrically conductive, soft and detachable; with black polyester Velcro straps; stainless steel load-bearing structure; pad (LxW): 450 mm x 130 mm height adjustment: 620 mm</p>	<p>4549755</p>
	<p>Arm holder for lateral position 450 T without clamp; viscous elastic FoamLine pads used for decubitus prophylaxis, electrically conductive, soft and detachable, with Velcro strap; with black polyester Velcro straps; stainless steel load-bearing structure; pad (LxW): 470 mm x 135 mm height adjustment: 620 mm</p>	<p>1493532</p>
	<p>Arm support device one hand operation with clamp and guide rail; to attach to side rails by frontal placement; swivel mounted with ball and socket joint and height adjustable; Comfort Plus pads integrally, foamed, electrically conductive, soft and detachable; black polyester Velcro strap; stainless steel load-bearing structure; pad (LxW): 620 mm x 130 mm height adjustment: 250 mm pivot range: +/- 40°</p>	<p>4549528</p>

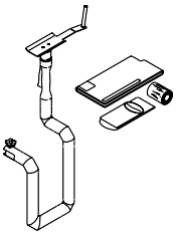
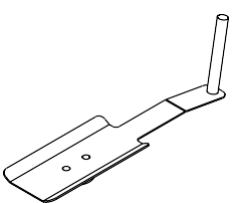
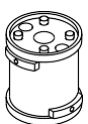
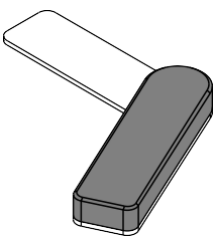
	Description	Material-No
	<p>Arm support device one hand operation T</p> <p>with clamp and guide rail; to attach to side rails by frontal placement; swivel mounted with ball and socket joint and height adjustable; viscous elastic FoamLine pads used for decubitus prophylaxis, electrically conductive, soft and detachable, with Velcro strap; black polyester Velcro strap; stainless steel load-bearing structure; pad (LxW): 620 mm x 130 mm height adjustment: 250 mm pivot range: +/- 40°</p>	1490931
	<p>Arm support with quick central fixation</p> <p>to attach to side rails (US,EU,J) by frontal placement; swivel range 360°; with viscous elastic pad for decubitus prophylaxis; stainless steel load-bearing structure; dimensions (LxWxH): 580 mm (by Baitella)</p>	2068136
	<p>Arm support one hand</p> <p>with clamp; to attach to 1317577 holding device for arm and leg; swivel mounted with ball and socket joint and height adjustable; Comfort Plus pad integrally foamed, electrically conductive, soft and detachable; black polyester Velcro strap; stainless steel load-bearing structure; pad (LxW): 600 mm x 130 mm height adjustment: 250 mm pivot range: +/- 40°</p>	4549529
	<p>Arm support one hand T</p> <p>with clamp; to attach to 1317577 holding device for arm and leg; swivel mounted with ball and socket joint and height adjustable; viscous elastic FoamLine pads used for decubitus prophylaxis, electrically conductive, soft and detachable, with Velcro strap; black polyester Velcro strap; stainless steel load-bearing structure; pad (LxW): 600 mm x 130 mm height adjustment: 250 mm pivot range: +/- 40°</p>	1490933
	<p>Arm support 450</p> <p>with clamp; to attach to side rails by frontal placement; swivel mounted and height adjustable; Comfort Plus pad integrally foamed, electrically conductive, soft and detachable; black polyester Velcro strap; stainless steel load-bearing structure; dimensions (LxW): 600 mm x 140 mm height adjustment: 170 mm</p>	4549778

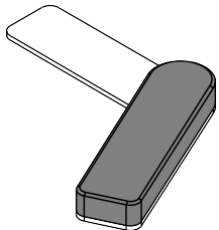
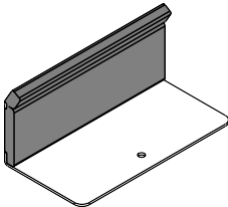
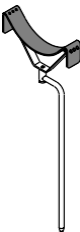
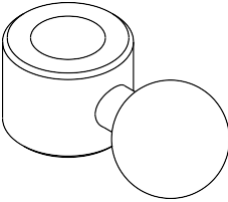
	Description	Material-No
	<p>Arm support 450 T</p> <p>with clamp; to attach to side rails by frontal placement; swivel mounted and height adjustable; viscous elastic FoamLine pads used for decubitus prophylaxis, electrically conductive, soft and detachable, with Velcro strap; black polyester Velcro strap; stainless steel load-bearing structure; dimensions (LxW): 600 mm x 140 mm height adjustment: 170 mm</p>	1483379
	<p>SchureLoc XPS Kit (EU)</p> <p>Original equipment consisting of the SchureLoc, a SchureLoc Adapter, a SchureLoc Forearm Attachment, and 3 items each of disposable sterile draping, sterile pads, and binding; for holding and flexible positioning of the patient's arm during surgery; attaches to the EU standard rail (by SchureMed)</p>	1908095
	<p>SchureLoc Forearm Attachment</p> <p>stainless steel arm support; attaches to the SchureLoc with the SchureLoc Adapter (by SchureMed)</p>	1905160
	<p>SchureLoc Adapter</p> <p>connector between the SchureLoc and SchureLoc Forearm Attachment (by SchureMed)</p>	1905159
	<p>Carbon Arm Board 50</p> <p>consists of base plate and arm support, which is rotatable 180°; transparent to X-rays; viscous elastic pad used for decubitus prophylaxis, with Velcro strap; made of Carbon fibres; recommended use with Comfort Plus table top pads; dimensions: base plate: 190 mm x 610 mm arm support: 150 mm x 580 mm height of pads: 50 mm (by Oakworks)</p>	1895202

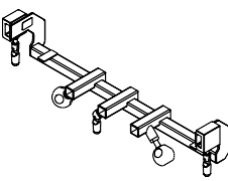
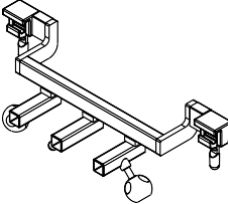
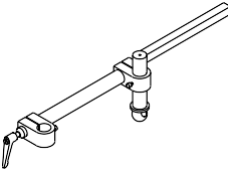

	Description	Material-No
	<p>Carbon Arm Board 75 consists of base plate and arm support, which is rotatable 180°; transparent to X-rays; viscous elastic pad used for decubitus prophylaxis, with Velcro strap; made of Carbon fibres; recommended use with Balanced and FoamLine table top pads; dimensions: base plate: 190 mm x 610 mm arm support: 150 mm x 580 mm height of pads: 75 mm (by Oakworks)</p>	<p>1895203</p>
	<p>Arm Shield, with pad is slid between table top and table top pad and held in place by the weight of the patient; not suited for tables or table tops with mushroom fasteners; made of Plexiglas; X-ray permeable; pad is soft, can be removed and used for decubitus prophylaxis; dimensions (LxH): 400 mm x 180 mm (by Allen Amatech)</p>	<p>1939050</p>
	<p>Leg support without clamp; height adjustable; with leather strap; stainless steel load-bearing structure</p>	<p>4544737</p>
	<p>Safety ring secures position of arm supports and arm supporting devices; stainless steel; diameter: 28 mm/ 16 mm</p>	<p>4544524</p>

1.6 Head Positioning

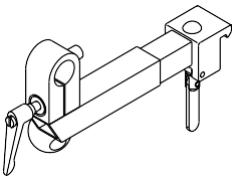
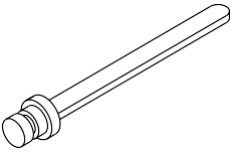
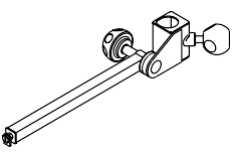
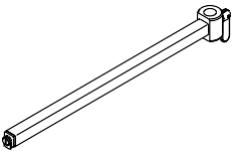
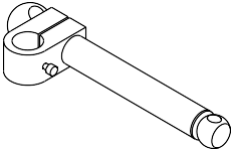
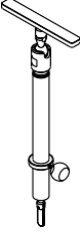
	Description	Material-No
	<p>Head ring for adults viscous elastic pad for positioning the patient's head in supine or prone position; used for adults; pad for decubitus prophylaxis; resistant to disinfectants; diameter: 220 mm height: 60 mm colour: black (by Simonsen & Weel)</p>	<p>1708609</p>
	<p>Head ring for children viscous elastic pad for positioning the patient's head in supine or prone position; used for children; pad for decubitus prophylaxis; resistant to disinfectants; diameter: 130/ 65 mm height: 30 mm colour: pink (by Simonsen & Weel)</p>	<p>1708611</p>
	<p>Pad for head positioning viscous elastic pad for positioning the patient's head in supine or prone position; pad for decubitus prophylaxis; resistant to disinfectants; dimensions (LxWxH): 250 mm x 300 mm x 110 mm colour: black (by Simonsen & Weel)</p>	<p>1708607</p>
	<p>Adapter for head positioning to attach to the side rails; for attaching head positioning accessories; stainless steel; dimensions: (130 mm x 620 mm x 160 mm)</p>	<p>1739994</p>
	<p>Adapter for head positioning to attach to Trumpf Medical coupling point system; for attaching head positioning accessories; stainless steel; spacer: 220 mm</p>	<p>4544785</p>
	<p>Central holder head rest system to attach to adapter for head positioning and ophthalmology adapter; central operating unit for setting height and angle of head rest; stainless steel</p>	<p>4544786</p>

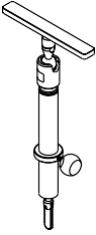
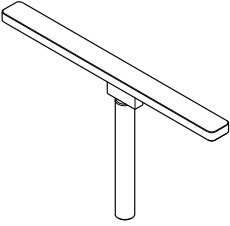
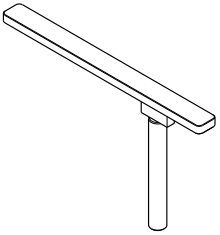
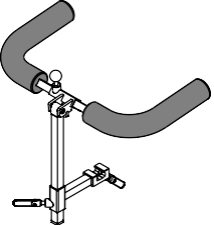
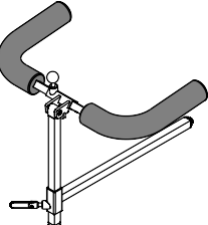
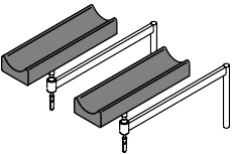

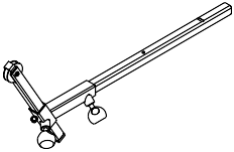
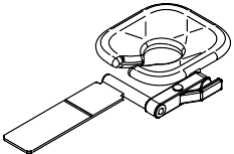
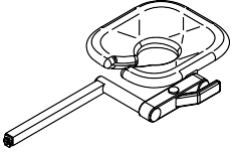
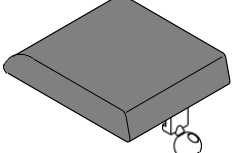
	Description	Material-No
	<p>Central holder head rest system basic to attach to Trumpf Medical coupling point system; stainless steel</p>	<p>4544788</p>
	<p>Connection holder to attach to central holder head rest system basic; stainless steel; dimensions (LxW): 10 mm x 25 mm length: 300 mm</p>	<p>4544728</p>
	<p>Retainer for head rests vario to attach to adapter for head positioning, Ophthalmology adapter or Shoulder basis segment; stainless steel; pivot range: +/- 90°</p>	<p>1300079</p>
	<p>Retainer for head rests to attach to adapter for head positioning, Ophthalmology adapter or Shoulder basis segment; stainless steel</p>	<p>1317948</p>
	<p>Cross joint for lateral positioning of connection holder with joint; increases free movement of head rests; stainless steel</p>	<p>4544787</p>
	<p>Connection holder with joint to attach to 4544786 central holder head rest system, 1300079 retainer for head rest Vario and 4544787 cross joint; stainless steel; length of side rail: 185 mm adjustment ball joint: rotatable: 360° tilt: +/- 30°</p>	<p>4544729</p>

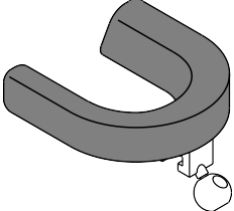
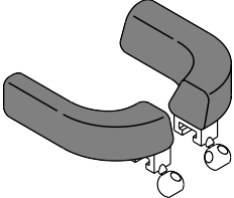
	Description	Material-No
	<p>Connection holder with joint short to attach to 4544786 central holder head rest system, 1300079 retainer for head rest Vario and 4544787 cross joint; stainless steel; length of side rail: 185 mm adjustment ball joint: rotatable: 360° tilt: +/- 30°</p>	<p>4544733</p>
	<p>Connection holder basic to attach to retainer for head rest; stainless steel</p>	<p>1254739</p>
	<p>Connection holder basic asymmetric to attach to retainer for head rest; stainless steel</p>	<p>1305449</p>
	<p>Wrist support to attach to the side rail of the connection holder; for surgeon's hand during micro-surgical interventions on eyes; bow hinged and adjustable height and transversal position; stainless steel load-bearing structure; height adjustment: 220 mm transversal shift: +/- 40 mm</p>	<p>1240299</p>
	<p>Wrist support 20 to attach to ophthalmology adapter; for surgeon's hand during micro-surgical interventions on eyes; bow hinged and adjustable height and transversal position; stainless steel load-bearing structure; height adjustment: 220 mm transversal shift: +/- 40 mm</p>	<p>1295542</p>
	<p>Arm support for surgeon pair without clamp; pad with a ball joint; Comfort Plus pads integrally foamed, electrically conductive, soft and detachable; stainless steel load-bearing structure; pad (LxWxH): 300 mm x 130 mm x 35/ 55 mm</p>	<p>4549767</p>

	Description	Material-No
	<p>Guiding roller for cervical traction for head-side traction; to attach to ophthalmology adapter sword retainer; stainless steel</p>	1446211
	<p>Head rest flat with one hand operation; to attach to ophthalmology adapter sword retainer</p>	1256031
	<p>Head rest flat 20 with one hand operation; to attach to Adapter for head positioning or Ophthalmology adapter</p>	1256701
	<p>Head rest basic with clamp; to attach to connection holder; Comfort Plus pad integrally foamed, electrically conductive and soft; stainless steel load-bearing structure; dimensions (LxW): 250 mm x 200 mm</p>	4549730
	<p>Head Rest horseshoe-shaped COMFORT with clamp; to attach to connection holder; head bowl with detachable pad; ideal pressure distribution when in supine or prone position; stainless steel load-bearing structure; dimensions: 180 mm x 180 mm</p>	1537214
	<p>Head rest horseshoe-shaped one part with clamp; to attach to connection holder; Comfort Plus pad integrally foamed, electrically conductive and soft; stainless steel load-bearing structure; dimensions (LxW): 180 mm x 180 mm</p>	4549731
	<p>Head rest horseshoe-shaped two parts with clamp; to attach to connection holder; adjustable to head size; Comfort Plus pad integrally foamed, electrically conductive and soft; stainless steel load-bearing structure; dimensions (LxW): 180 mm x 180 mm</p>	4549732

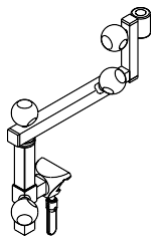
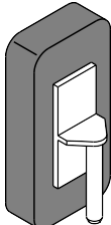
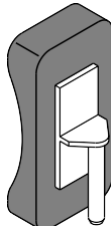
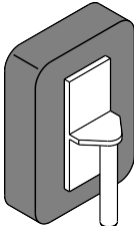
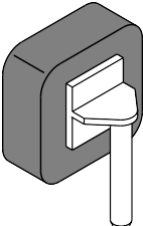
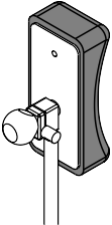
1.7 Supports

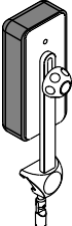
	Description	Material-No
	<p>Universal lateral support height adjuster with clamp; to attach to side rails by frontal placement; to attach lateral supports; pad can be individually adjusted; stainless steel; height adjustment: 300 mm lengthwise pullout: 160 mm pivot joint: 360°</p>	<p>4544719</p>
	<p>Lateral support 215 to attach to lateral supports; pad integrally foamed, electrically conductive, soft and detachable; pad (LxWxH): 100 mm x 215 mm x 50 mm</p>	<p>4544721</p>
	<p>Lateral support 215 concave to attach to lateral supports; pad integrally foamed, electrically conductive, soft and detachable; pad (LxWxH): 100 mm x 215 mm x 35/ 56 mm</p>	<p>4544764</p>
	<p>Lateral support 170 to attach to lateral supports; for back and buttocks support; pad integrally foamed, electrically conductive, soft and detachable; pad (LxWxH): 120 mm x 170 mm x 50 mm</p>	<p>4544722</p>
	<p>Lateral support 85 to attach to lateral supports; for pubis support; pad integrally foamed, electrically conductive, soft and detachable; pad (LxWxH): 85 mm x 85 mm x 50 mm</p>	<p>4544723</p>
	<p>Pad swivel-mounted to attach to lateral supports; pad integrally foamed, electrically conductive, soft and detachable; stainless steel load-bearing structure; pad (LxWxH): 215 mm x 100 mm x 50 mm</p>	<p>4544192</p>

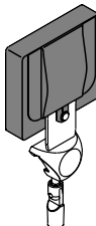
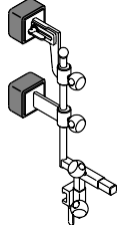
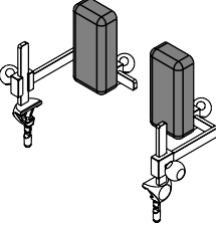

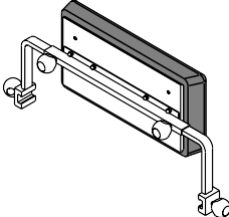
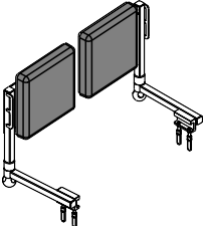
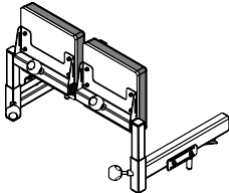
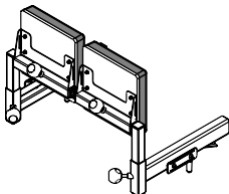
	Description	Material-No
	<p>Lateral support height adjustable with clamp; to attach to side rails; pad integrally foamed, electrically conductive, soft and detachable; stainless steel load-bearing structure; pad (LxWxH): 215 mm x 100 mm x 50 mm height adjustment: 50 mm pad rotation: 360°</p>	<p>1496430</p>
	<p>Lateral support height adjustable concav with clamp; to attach to side rails; pad integrally foamed, electrically conductive, soft and detachable; stainless steel load-bearing structure; pad (LxWxH): 215 mm x 100 mm x 50 mm height adjustment: 50 mm pad rotation: 360°</p>	<p>1496431</p>
	<p>Lateral support short with clamp; to attach to side rails; pad integrally foamed, electrically conductive, soft and detachable; stainless steel load-bearing structure; pad (LxWxH): 140 mm x 130 mm x 30 mm</p>	<p>1436371</p>
	<p>Pelvis support with clamp; for lateral positioning; pads can be adjusted to pelvis width; pads integrally foamed, electrically conductive, soft and detachable; pad (LxWxH): 85 mm x 85 mm x 50 mm</p>	<p>4544773</p>
	<p>Shoulder support height adjustable pair; with clamp; to attach to side rails by frontal placement; height adjustable; adjustable longitudinal and transversal to the operating table top; pad integrally foamed, electrically conductive, soft and detachable; stainless steel load-bearing structure; longitudinal shift: 130 mm transversal shift: 90 mm</p>	<p>1679646</p>

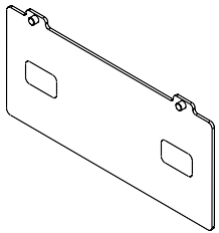
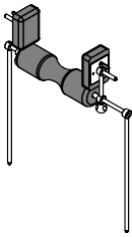
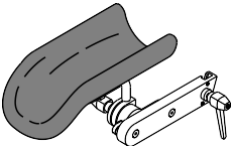
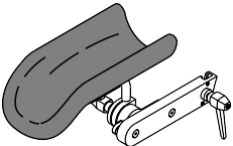
	Description	Material-No
	<p>Shoulder support height adjustable T</p> <p>pair; with clamp; to attach to side rails by frontal placement; height adjustable; adjustable longitudinal and transversal to the operating table top; viscous elastic FoamLine pads used for decubitus prophylaxis, electrically conductive, soft and detachable; stainless steel load-bearing structure; longitudinal shift: 130 mm transversal shift: 90 mm</p>	1680904
	<p>Shoulder pad L-shaped</p> <p>viscous elastic pad for decubitus prophylaxis; resistant to disinfectants; dimensions (LxWxH 165 mm x 180 mm x 150 mm (by Simonsen & Weel)</p>	1708617
	<p>Foot support</p> <p>to attach to side rails via clamp; continuous adjustable to table top width; pad integrally foamed, electrically conductive and soft; stainless steel load-bearing structure</p>	4544421
	<p>Foot support two parts</p> <p>to attach to side rails via clamp; swivel joint enables proper patient positioning; Comfort Plus pads integrally foamed, electrically conductive, soft and detachable; stainless steel load-bearing structure</p>	1265545
	<p>Foot support universal</p> <p>to attach to side rails with 25 mm x 10 mm dimensions of leg sections via clamp; swivel joint enables proper patient positioning; Comfort Plus pads integrally foamed, electrically conductive, soft and detachable; stainless steel load-bearing structure</p>	1524566
	<p>Foot support universal U</p> <p>to attach to side rails with 28.6 mm x 9.5 mm dimensions of leg sections via clamp; swivel joint enables proper patient positioning; Comfort Plus pads integrally foamed, electrically conductive, soft and detachable; stainless steel load-bearing structure</p>	1542498

	Description	Material-No
	<p>Connector plate allows to use the foot support universal as a one-part foot support</p>	<p>1524567</p>
	<p>Iliac roll with lateral support without clamp; adjustable to table top width; lateral supports can be adjusted to body width; pads integrally foamed, electrically conductive and soft; stainless steel; height adjustment: 400 mm</p>	<p>4544761</p>
	<p>Knee support right to attach to Trumpf Medical leg sections (dimensions side rail: 25 mm x 10 mm); swivel mounted; for rectal positioning; pad integrally foamed, electrically conductive and soft; stainless steel</p>	<p>1395188</p>
	<p>Knee support left to attach to Trumpf Medical leg sections (dimensions side rail: 25 mm x 10 mm); swivel mounted; for rectal positioning; pad integrally foamed, electrically conductive and soft; stainless steel</p>	<p>1395189</p>

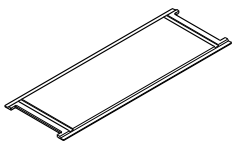
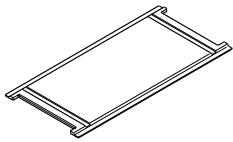
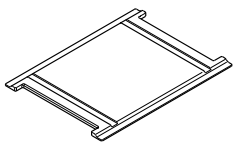
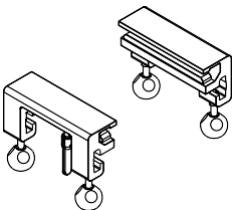
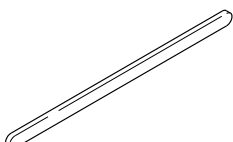
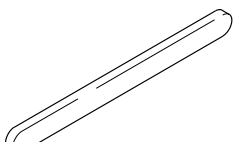
2 Carbon and Accessories

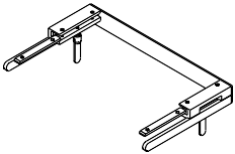
	Description	Material-No
	<p>Joint plate Carbon 520 used with Clamp pair for joint plate Carbon 1272324; Carbon fibre; dimensions (LxWxH): 200 mm x 570 mm x 6 mm</p>	1266934
	<p>Joint plate Carbon 370 used with Clamp pair for joint plate Carbon 1272324; Carbon fibre; dimensions (LxWxH): 200 mm x 420 mm x 6 mm</p>	1279867
	<p>Joint plate Carbon 220 used with Clamp pair for joint plate Carbon 1272324; Carbon fibre; dimensions (LxWxH): 200 mm x 270 mm x 6 mm</p>	1229593
	<p>Clamp pair for joint plate Carbon retains joint plates Carbon and side rails; this combination can be attached and slid along the whole length of the segments and table tops without impairing X-ray capability; stainless steel</p>	1272324
	<p>Side rail stainless steel; length: 520 mm dimensions side rail: 25 mm x 10 mm</p>	4544166
	<p>Side rail U stainless steel; length: 20 mm) dimensions side rail: 28.6 mm x 9.5 mm</p>	4500166
	<p>Side rail short stainless steel; length: 300 mm dimensions side rail 25 mm x 10 mm</p>	1317780

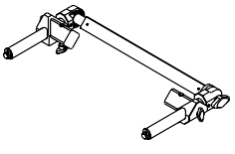
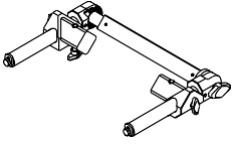
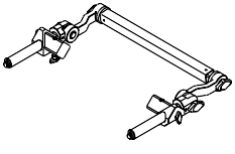
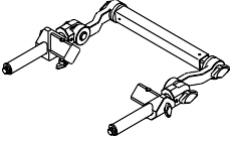
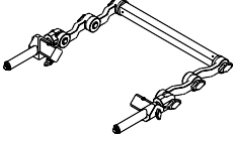
	Description	Material-No
	<p>Side rail adapter Carbon to attach to operating table tops Carbon; adapter for attaching special accessories; stainless steel dimensions side rail: 25 mm x 10 mm</p>	<p>1249777</p>
	<p>Side rail long connection between side rails of operating table tops Carbon and side rail adapter Carbon; stainless steel; dimensions side rail: 25 mm x 10 mm</p>	<p>4544536</p>
	<p>Adapter X-RAY wide to attach to table tops Carbon and table top segments Carbon with coupling point Carbon; for attaching head positioning accessories; Carbon fibre</p>	<p>1312733</p>
	<p>Adapter X-RAY narrow to attach to table top segments Carbon narrow with coupling point Carbon; for attaching head positioning accessories; Carbon fibre</p>	<p>1297206</p>
	<p>Adapter X-RAY double joint wide to attach to table tops Carbon and table top segments Carbon with coupling point Carbon; for attaching head positioning accessories; Carbon fibre</p>	<p>1312735</p>
	<p>Adapter X-RAY double joint narrow to attach to table top segments Carbon narrow with coupling point Carbon; for attaching head positioning accessories; Carbon fibre</p>	<p>1312734</p>
	<p>Adapter X-RAY 3-joint wide to attach to table tops Carbon and table top segments Carbon with coupling point Carbon; for attaching head positioning accessories; Carbon fibre</p>	<p>1430024</p>

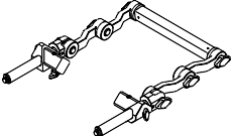
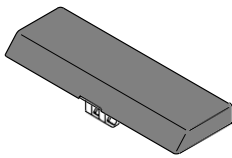
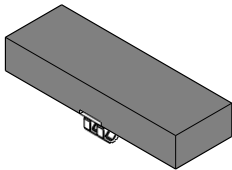
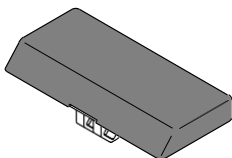
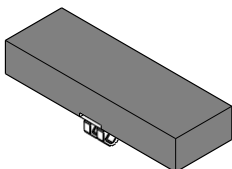
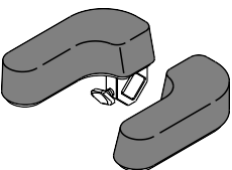

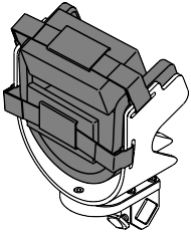
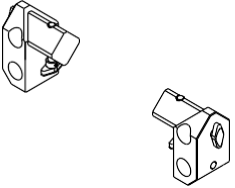
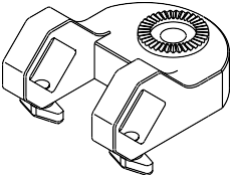
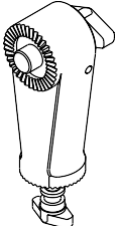
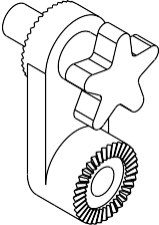
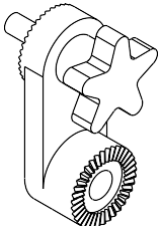
	Description	Material-No
	<p>Adapter X-RAY 3-joint narrow to attach to table top segments Carbon narrow with coupling point Carbon; for attaching head positioning accessories; Carbon fibre</p>	<p>1430023</p>
	<p>Head section X-RAY wide for head positioning; to attach to all adapters X-RAY wide; fully translucent; Comfort Plus pad integrally foamed, electrically conductive, soft and detachable; dimensions (LxW): 200 mm x 530 mm</p>	<p>1297207</p>
	<p>Head section X-RAY wide T for head positioning; to attach to all adapters X-RAY wide; fully translucent; viscous elastic FoamLine pads used for decubitus prophylaxis, electrically conductive, soft and detachable, with Velcro strap; dimensions (LxW): 200 mm x 530 mm</p>	<p>1424577</p>
	<p>Head section X-RAY narrow for head positioning; to attach to all adapters X-RAY; Comfort Plus pad integrally foamed, electrically conductive, soft and detachable; dimensions (LxW): 200 mm x 380 mm</p>	<p>1300664</p>
	<p>Head section X-RAY narrow T for head positioning; to attach to all adapters X-RAY; viscous elastic FoamLine pads used for decubitus prophylaxis, electrically conductive, soft and detachable, with Velcro strap; dimensions (LxW): 200 mm x 380 mm</p>	<p>1424588</p>
	<p>Head rest X-RAY to attach to all adapters X-RAY; adjustable to head size; Comfort Plus pad integrally foamed, electrically conductive, soft and detachable; dimensions (LxWxH): 200 mm x 250 mm x 100 mm adjustment range: +/- 45°</p>	<p>1300662</p>

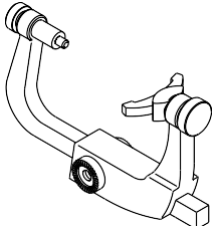
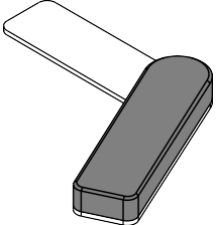
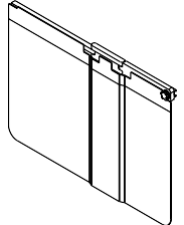
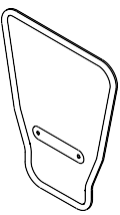

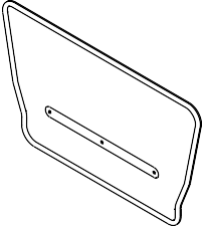

	Description	Material-No
	<p>Helmet X-RAY to attach to all adapters X-RAY; fully radiolucent; U-shaped helmet with soft pads and two fixation straps with Velcro fasteners for safe positioning and lateral fixation of the head while patient is anaesthetized; adjustable to various head sizes, ranging from adults to children; detachable pads</p>	<p>1300663</p>
	<p>Coupling piece X-RAY low used for the lower head position while using 1317569 skull clamp X-RAY; carbon-fibre</p>	<p>1368880</p>
	<p>Retainer X-RAY to attach to all adapters X-RAY; to attach the swivel adapter X-RAY 1317786; compatible with CT and MRI</p>	<p>1345749</p>
	<p>Swivel adapter X-RAY to attach 1317569 Skull clamp X-RAY to 1345749 Retainer X-RAY or as connection piece between 1866513 Interface Skull Clamp AL and 1218968 Skull clamp; material is compatible with CT and MRI</p>	<p>1317786</p>
	<p>Interface Skull Clamp radiolucent to attach the radiolucent Skull clamp to basic unit made of aluminium; is used as connection piece between 1218970 Basic unit neuro, 1218969 Scull clamp adapter and 1317569 Skull clamp X-RAY; connection of a biopsy arm possible; material is compatible with CT and MRI (by Pro Med Instruments GmbH)</p>	<p>1835762</p>
	<p>Interface Skull Clamp AL to attach the Skull clamp made of aluminium to the radiolucent head rest system; is used as connection piece between 1251251 Head rest system radiolucent, 1317786 Swivel adapter X-RAY and 1218968 Skull clamp; connection of a DBS adapter possible; material is compatible with CT and MRI (by Pro Med Instruments GmbH)</p>	<p>1866513</p>

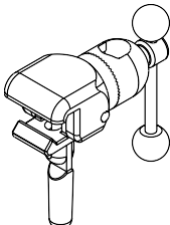
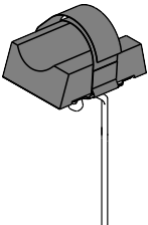
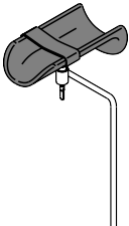
	Description	Material-No
	<p>Skull clamp X-RAY to attach to 1317786 Swivel adapter X-RAY or 1835762 Interface Skull Clamp radiolucent; stable and precise three-point skull fixation; modular fixation system for skull pins and elastic pads; suitable for children and adults of all ages; material is compatible with CT and MRI; dimensions (LxWxH): 302 mm - 410 mm x 140 mm x 360 mm (by Pro Med Instruments GmbH)</p>	<p>1317569</p>
	<p>Carbon Arm Board 50 consists of base plate and arm support, which is rotatable 180°; transparent to X-rays; viscous elastic pad used for decubitus prophylaxis, with Velcro strap; made of Carbon fibres; recommended use with Comfort Plus table top pads; dimensions: base plate: 190 mm x 610 mm arm support: 150 mm x 580 mm height of pads: 50 mm (by Oakworks)</p>	<p>1895202</p>
	<p>Carbon Arm Board 75 consists of base plate and arm support, which is rotatable 180°; transparent to X-rays; viscous elastic pad used for decubitus prophylaxis, with Velcro strap; made of Carbon fibres; recommended use with Balanced and FoamLine table top pads; dimensions: base plate: 190 mm x 610 mm arm support: 150 mm x 580 mm height of pads: 75 mm (by Oakworks)</p>	<p>1895203</p>
	<p>Lower body table shield used for X-ray protection; to attach to side rail; can be used universally; adapts to table movements; dimensions: 930 mm x 700 mm (by Kenex (Electro-Medical) Ltd)</p>	<p>1946701</p>
	<p>Wide lift-off top shield 27 attachment for lower body table shield #1946701; attachment via cross-connection; stands 250 mm over standard rail; flexible and removable; width: 270 mm (by Kenex (Electro-Medical) Ltd)</p>	<p>1946702</p>

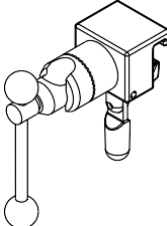
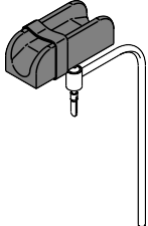
	Description	Material-No
	<p>Wide lift-off top shield 57 attachment for lower body table shield 1946701; attachment via movable arm; stands 250 mm over standard rail; flexible and removable; width: 570 mm (by Kenex (Electro-Medical) Ltd)</p>	<p>1946703</p>

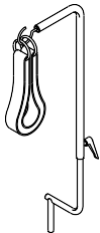
3 Gynaecology/ Urology

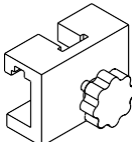

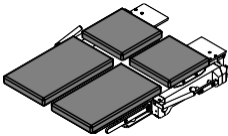
	Description	Material-No
	Radial setting clamp HEAVY version for heavy loads; to attach to side rails by frontal placement; 360° adjustment; suitable for rods of 15 mm - 20 mm diameter; stainless steel	4544530
	Leg holder HEAVY T without clamp; viscous elastic FoamLine pad used for decubitus prophylaxis, electrically conductive, soft and detachable, with Velcro strap; stainless steel frame	1506318
	Leg holder GOEPEL without clamp; pad integrally foamed, electrically conductive and soft; stainless steel load-bearing structure	4544736
	Pad for leg holder Goepel pad for leg holder Goepel 4544736; viscous elastic pad for decubitus prophylaxis; resistant to disinfectants; fixation on leg holder via Velcro strap; dimensions (LxWxH): 550 mm x 770 mm x 20 mm (by Simonsen & Weel)	1703517
	Clamp radial setting to attach to side rails by frontal placement; for heavy loads; 360° adjustment; suitable for rods 15 mm - 18 mm in diameter; stainless steel	1218804
	Leg holder GOEPEL for children without clamp; pad integrally foamed, electrically conductive and soft; stainless steel load-bearing structure	4544789

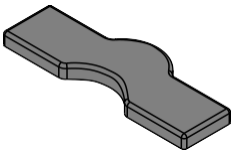
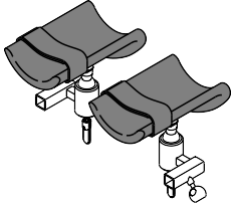
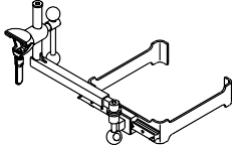
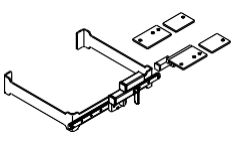
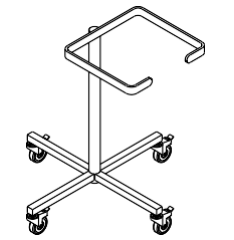
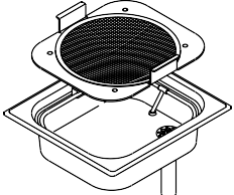
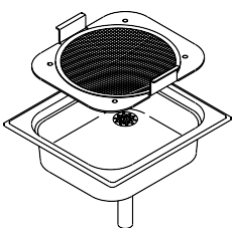
	Description	Material-No
	<p>Leg holder with strap pair without clamp; height adjustable; strap cotton fabric; stainless steel load-bearing structure; length: 640 mm x 750 mm</p>	<p>1218811</p>
	<p>Leg holder with strap padded pair without clamp; height adjustable and rotatable; strap black polyester; stainless steel load-bearing structure</p>	<p>4544796</p>
	<p>Clamp for leg holder for legholder left 1228196 and leg holder right 1228197; to attach on EU-side rails; for a complete leg holder set 2 clamps are required (by Allen Amatech)</p>	<p>1228198</p>
	<p>Clamp for leg holder (US) for legholder left 1228196 and leg holder right 1228197; to attach on US-side rails (by Allen Amatech)</p>	<p>2008954</p>
	<p>Leg holder left without clamp; easily adjustable through gas-spring supported mechanism; one handed operating; marks for position adjustment; only with leg holder right 1228197 available (as a pair) (by Allen Amatech)</p>	<p>1228196</p>
	<p>Leg holder right without clamp; easily adjustable through gas-spring supported mechanism; one handed operating; marks for position adjustment; only with leg holder left 1228196 available (as a pair) (by Allen Amatech)</p>	<p>1228197</p>
	<p>LegMaster four-part leg section with combined lift-and-spread mechanism for lithotomy procedures; lower leg pads are longitudinal adjustable and detachable; upper leg pads are detachable; pads are integrally foamed, electrically conductive and soft; stainless steel load-bearing structure; dimensions (LxWxH): 900 mm x 320 mm x 150 mm spread ankle: 45° leg up/down: + 95° / - 130°</p>	<p>1412708</p>

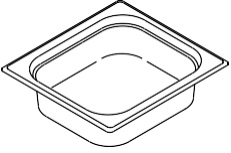
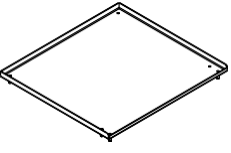
	Description	Material-No
	<p>Pad for LegMaster pad integrally foamed, electrically conductive and soft</p>	<p>4544547</p>
	<p>Leg holder GOEPEL for LegMaster pair; pads integrally foamed and electrically conductive</p>	<p>4544473</p>
	<p>Drainage bowl adapter with clamp; to attach to side rail; guide rail allows precise adjustment in x- and y-directions; stainless steel</p>	<p>4544619</p>
	<p>Drainage bowl adapter pelvis extension to attach to pelvis extensions; for securing and positioning drainage bowls; stainless steel</p>	<p>1296302</p>
	<p>Drainage bowl stand to attach drainage bowls; mobile; stainless steel (by BLANCO CZ, spol.sr.o.)</p>	<p>4544492</p>
	<p>Drainage bowl with water inlet with sieve; suitable for all drainage bowl adapters; with hose connectors for drainage and supply; protection of overflow; stainless steel</p>	<p>4544495</p>
	<p>Drainage bowl with sieve; suitable for all drainage bowl adapters; hose connectors for drainage; stainless steel</p>	<p>4544618</p>

	Description	Material-No
	<p>Collection bowl suitable for all drainage bowl adapters; stainless steel</p>	<p>1218883</p>
	<p>Instrument tray suitable for all drainage bowl adapters; stainless steel; dimensions (LxWxH): 353 mm x 323 mm x 32 mm</p>	<p>1286562</p>

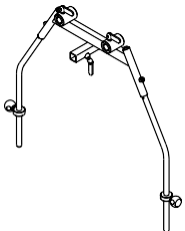
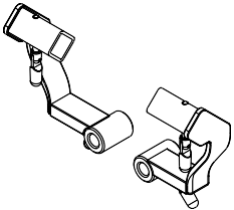
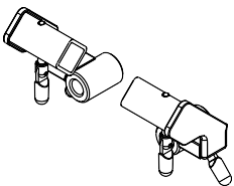
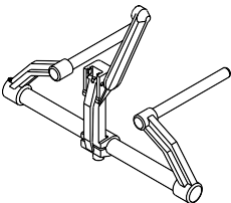
4 Neurosurgery

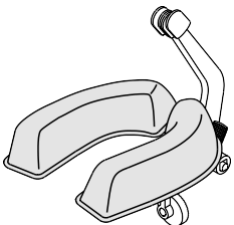
	Description	Material-No
	<p>Crossbar attachment without clamp; for attaching neurosurgical accessories; stainless steel; height adjustment: 230 mm</p>	<p>4544436</p>
	<p>Neuroadapter Carbon wide to attach to table tops Carbon and the table top segment Carbon 600; secures 1218970 basic unit neuro; stainless steel</p>	<p>1435067</p>
	<p>Neuroadapter Carbon narrow to attach to table top segment Carbon narrow; secures 1218970 basic unit neuro; stainless steel</p>	<p>1433543</p>
	<p>Basic unit neuro for attaching 1218969 Skull clamp adapter; simultaneous locking of longitudinal and vertical positions; used for prone and supine position of the patient; cast aluminum (by Pro Med Instruments GmbH)</p>	<p>1218970</p>
	<p>Skull clamp adapter connection between 1218970 basic unit neuro, 1218968 skull clamp or 4145424 multi-purpose head rest; cast aluminum (by Pro Med Instruments GmbH)</p>	<p>1218969</p>
	<p>Head rest for adults adjustable to head size; to connect to 1218969 skull clamp adapter; with detachable, elastic gel pad; used for prone and supine position of the patient; cast aluminum (by Pro Med Instruments GmbH)</p>	<p>1218974</p>

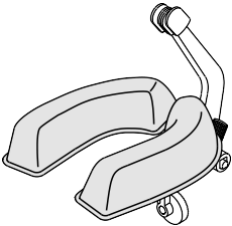
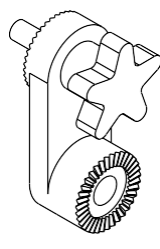
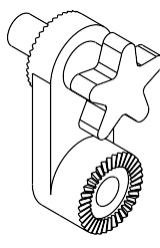
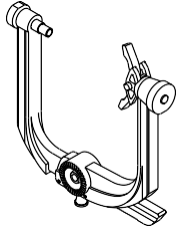
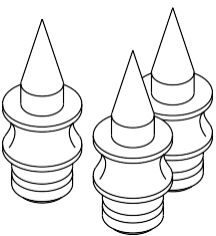
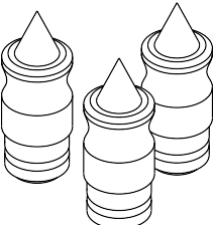

	Description	Material-No
	<p>Head rest for children adjustable to head size; to connect to 1218969 skull clamp adapter; with detachable, elastic gel pad; used for prone and supine position of the patient; cast aluminum (by Pro Med Instruments GmbH)</p>	<p>1218973</p>
	<p>Interface Skull Clamp AL to attach the Skull clamp made of aluminium to the radiolucent head rest system; is used as connection piece between 1251251 Head rest system radiolucent, 1317786 Swivel adapter X-RAY and 1218968 Skull clamp; connection of a DBS adapter possible; material is compatible with CT and MRI (by Pro Med Instruments GmbH)</p>	<p>1866513</p>
	<p>Interface Skull Clamp radiolucent to attach the radiolucent Skull clamp to basic unit made of aluminium; is used as connection piece between 1218970 Basic unit neuro, 1218969 Skull clamp adapter and 1317569 Skull clamp X-RAY; connection of a biopsy arm possible; material is compatible with CT and MRI (by Pro Med Instruments GmbH)</p>	<p>1835762</p>
	<p>Skull clamp to attach to 1218969 skull clamp adapter or 1866513 Interface Skull Clamp AL; stable and precise three-point skull fixation with skull pins; cast aluminum (by Pro Med Instruments GmbH)</p>	<p>1218968</p>
	<p>Skull pins for adults sterilisable; made of stainless steel; package with three pieces (by Pro Med Instruments GmbH)</p>	<p>4145420</p>
	<p>Skull pins for children sterilisable; made of stainless steel; package with three pieces (by Pro Med Instruments GmbH)</p>	<p>4145421</p>

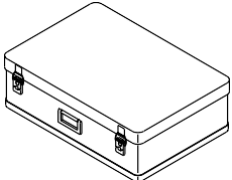
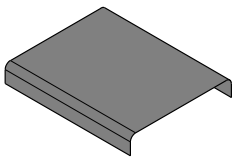
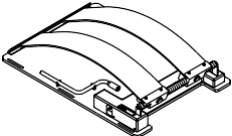
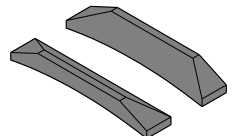
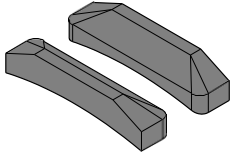
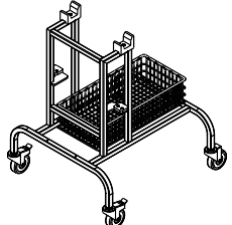

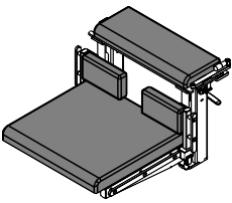
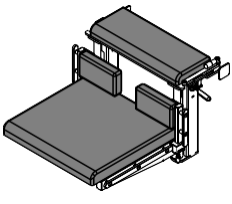
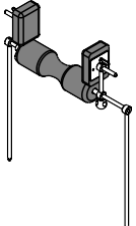
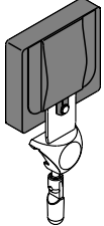
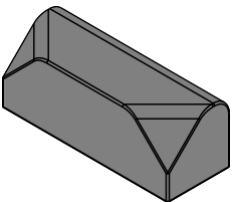
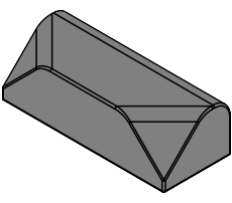
5 Spine surgery

	Description	Material-No
	<p>Transport case for transporting and storing 1337640 spine bridge Wilson; aluminium (by KS TechnoCase GmbH)</p>	<p>1337641</p>
	<p>Pad protection to protect the pad underneath Spine bridge WILSON; dimensions: 800 mm x 620 mm</p>	<p>1756164</p>
	<p>Spine bridge WILSON V to put on OR table tops; belts inclusive to fix spine bridge to side rails; with crank for height adjustment; adjustable flexion range; unrestricted radiolucency; with Velcro; 1756164 pad protection recommended to protect OR table mattress</p> <p>1</p>	<p>1790125</p>
	<p>Pad spine bridge WILSON set viscous elastic pad, with Velcro strap; as initial equipment for spine bridge WILSON</p>	<p>1783316</p>
	<p>Pad spine bridge WILSON M set viscous elastic pad used for decubitus prophylaxis inclusive fitting lubricant, soft and detachable; with Velcro strap; covers are washable; as initial equipment for spine bridge WILSON (by mediPlac GmbH)</p>	<p>1852424</p>
	<p>Trolley spinal cord positioning device for positioning and transport of spinal cord positioning devices; during column or shuttle use; stainless steel</p> <p>1</p>	<p>1432336</p>

	Description	Material-No
	<p>Spinal cord positioning device to attach to Trumpf Medical coupling point system at foot end; used to position patient knees during spinal column surgeries; with crank for height adjustment; motorized leg section joints for up and down movements; radiolucent via C-arm; pad electrically conductive, soft and detachable; Velcro-fastened pad; stainless steel load-bearing structure; height adjustment: 300 mm</p>	<p>1361398</p>
	<p>Spinal cord positioning device SATURN to attach to TRUMPF coupling points at foot end of SATURN Select operating tables and SATURN System operating table tops; used to position patient knees during spinal column surgeries; with crank for height adjustment; radiolucent via C-arm; pad electrically conductive, soft and detachable; Velcro-fastened pad; stainless steel load-bearing structure; height adjustment: 300 mm</p>	<p>1440415</p>
	<p>Iliac roll with lateral support without clamp; adjustable to table top width; lateral supports can be adjusted to body width; pads integrally foamed, electrically conductive and soft; stainless steel; height adjustment: 400 mm</p>	<p>4544761</p>
	<p>Lateral support short with clamp; to attach to side rails; pad integrally foamed, electrically conductive, soft and detachable; stainless steel load-bearing structure; pad (LxWxH): 140 mm x 130 mm x 30 mm</p>	<p>1436371</p>
	<p>Cushion for sternum support large to support the patient's thorax; foam pad; dimensions (LxWxH): 200 mm x 580 mm x 200 mm</p>	<p>1436370</p>
	<p>Cushion for sternum support small to support the patient's thorax; foam pad; dimensions (LxWxH): 200 mm x 480 mm x 150 mm</p>	<p>1436366</p>

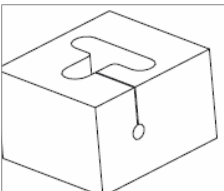
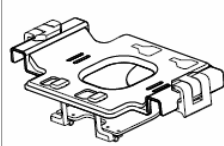
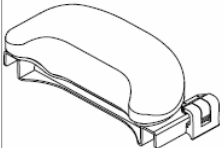
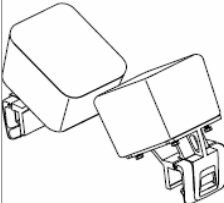
	Description	Material-No
	<p>Cushion for sternum support viscous elastic pad for supporting the patient's thorax in prone position; pad for decubitus prophylaxis; resistant to disinfectants; dimensions (LxWxH): 550 mm x 170 mm x 120 mm colour: yellow (by Simonsen & Weel)</p>	<p>1708605</p>
	<p>Jack knife pad viscous elastic pad for rectal positioning of patients; pad for decubitus prophylaxis; resistant to disinfectants; dimensions (LxWxH): 330 mm x 620 mm x 380 mm colour: yellow (by Simonsen & Weel)</p>	<p>1708603</p>
	<p>Thorax pad H-shaped viscous elastic pad for operation at intervertebral disc; for prone position; pad for decubitus prophylaxis; resistant to disinfectants; dimensions (LxWxH): 300 mm x 500 mm x 160 mm colour: yellow (by Simonsen & Weel)</p>	<p>1703518</p>
	<p>Head pad prone position 70 viscous elastic pad for positioning the patient's head in prone position; pad for decubitus prophylaxis; resistant to disinfectants; dimensions (LxWxH): 250 mm x 230 mm x 70 mm colour: black (by Simonsen & Weel)</p>	<p>1708612</p>
	<p>Head pad prone position 150 viscous elastic pad for positioning the patient's head in prone position; pad for decubitus prophylaxis; resistant to disinfectants; dimensions (LxWxH): 250 mm x 280 mm x 150 mm colour: black (by Simonsen & Weel)</p>	<p>1708613</p>
	<p>Head pad prone position round viscous elastic, circular shaped pad for positioning the patient's head in prone position; pad for decubitus prophylaxis; resistant to disinfectants; diameter: 320 mm height: 170/ 140 mm colour: black (by Simonsen & Weel)</p>	<p>1708614</p>

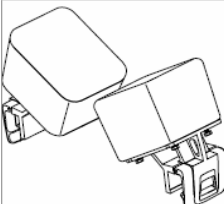
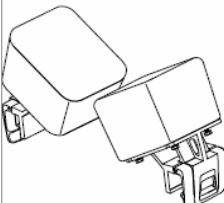
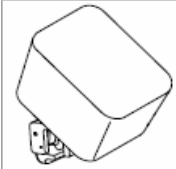
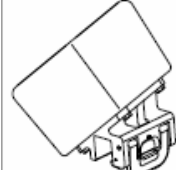
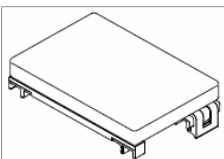

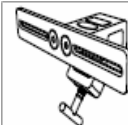
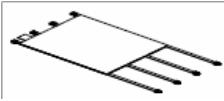
	Description	Material-No
	<p>Knee pad for prone position pad for positioning of the knee in prone position; pad for decubitus prophylaxis; resistant to disinfectants; diameter:220 mm height: 60 mm colour: yellow (by Simonsen & Weel)</p>	<p>1708604</p>
	<p>Pad roll 150 viscous elastic, circular shaped pad for positioning of the legs in prone position; pad for decubitus prophylaxis; resistant to disinfectants; diameter: 150 mm length: 500 mm colour: yellow (by Simonsen & Weel)</p>	<p>1708578</p>
	<p>Pad roll 100 viscous elastic, circular shaped pad for positioning of the legs in prone position; pad for decubitus prophylaxis; resistant to disinfectants; diameter: 100 mm length: 350 mm colour: yellow (by Simonsen & Weel)</p>	<p>1708579</p>
	<p>Foam Head Block, Disposable for positioning the patient's head in prone position with Spine Frame Advanced System; 6 units per package (by Allen Amatech)</p>	<p>2016441</p>
	<p>Advance Head Plate for positioning the patient's head in prone position with OR table top Carbon Spine (by Allen Amatech)</p>	<p>2065999</p>
	<p>Advance Chest Support with Pad for positioning the patient in prone position with OR table top Carbon Spine (by Allen Amatech)</p>	<p>2066000</p>
	<p>Advance Hip support- MED w/pad for positioning the patient in prone position with OR table top Carbon Spine Size: M (by Allen Amatech)</p>	<p>2066001</p>

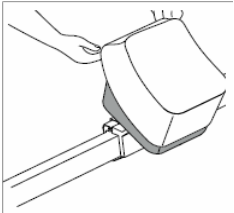

	Description	Material-No
	Advance Hip support- SM w/pad for positioning the patient in prone position with OR table top Carbon Spine Size: S (by Allen Amatech)	2066002
	Advance Hip Support- LG w/pad for positioning the patient in prone position with OR table top Carbon Spine Size: L (by Allen Amatech)	2066003
	Advance Thigh Support w/pad-Left for positioning the patient in prone position with OR table top Carbon Spine; left (by Allen Amatech)	2066005
	Advance Thigh Support w/pad-right for positioning the patient in prone position with OR table top Carbon Spine; right (by Allen Amatech)	2066006
	Supine Accessory Top 12" for positioning the patient with OR table top Carbon Spine (by Allen Amatech)	2066007
	Supine Accessory Top Pad 12" pad for Supine Accessory Top 12" (by Allen Amatech)	2066008
	Rail Top Armboard Rail (EU) to attach to OR table top Carbon Spine; with side rail dimensions 25 mm x 10 mm;EU (by Allen Amatech)	2066010
	Accessory Rail Clamp, EU, T5 clamp for attaching a retractor on the OR table top Carbon Spine; EU (by Allen Amatech)	2066018
	Sling Support for the inverse spine positioning; to attach to the struts of the OR table top Carbon Spine (by Allen Amatech)	2066015

	Description	Material-No
	<p>Ultra Comfort Covers, Medium protection covers for the pads of the Spine Frame Advanced System; Size: M Package with 6 pieces (by Allen Amatech)</p>	<p>2016447</p>
	<p>Ultra Comfort Cover, Large protection covers for the pads of the Spine Frame Advanced System; Size: L Package with 6 pieces (by Allen Amatech)</p>	<p>2016448</p>
	<p>Ultra Comfort Covers, Small protection covers for the pads of the OR table top Carbon Spine; Size: S case of 6 pieces (by Allen Amatech)</p>	<p>2066017</p>

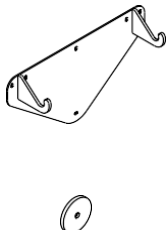

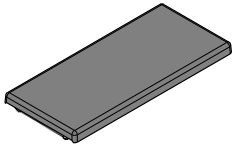
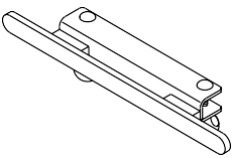
6 Orthopaedics/ Traumatology

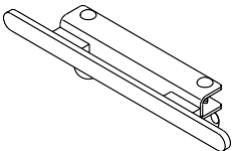
6.1 Standard Accessories Orthopedics

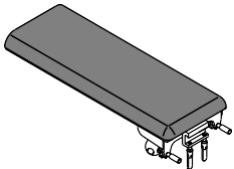
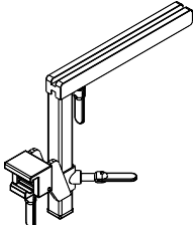
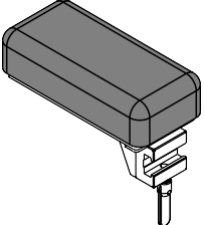
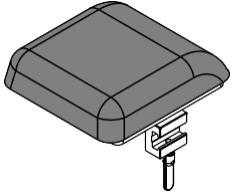
	Description	Material-No
	<p>Holder for hand operating table to mount 4549735 hand operating table to wall; stainless steel</p>	<p>1303645</p>
	<p>Hand operating table with clamp; table top and supports on wheels height adjustable; Comfort Plus pad integrally foamed, electrically conductive, soft and detachable; stainless steel load-bearing structure; pad (LxW): 820 mm x 360 mm height adjustment: table top: 70 mm support on wheels: 400 mm pivot range: +/- 45°</p>	<p>4549735</p>
	<p>Hand operating table T with clamp; table top and supports on wheels height adjustable; viscous elastic FoamLine pads used for decubitus prophylaxis, electrically conductive, soft and detachable, with Velcro strap; stainless steel load-bearing structure; pad (LxW): 840 mm x 370 mm height adjustment: table top: 70 mm support on wheels: 400 mm pivot range: +/- 45°</p>	<p>1504060</p>
	<p>Hand operating table Carbon to attach to side rails; arm support; Comfort Plus pad integrally foamed, electrically conductive, soft and detachable; Carbon fibre; dimensions (LxWxH): 885 mm x 380 mm x 150 mm</p>	<p>1227687</p>
	<p>Side rail extension H to attach additional accessories; stainless steel; dimensions side rail: 25 mm x 10 mm</p>	<p>1232675</p>

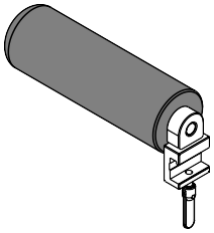
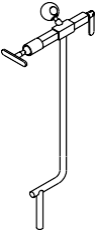
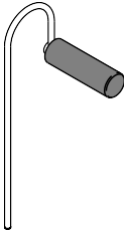
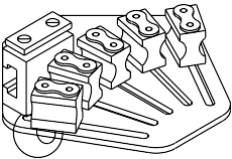
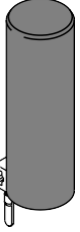
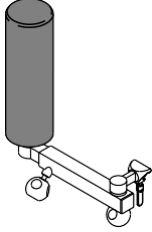

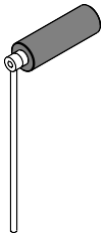
	Description	Material-No
	Side rail extension H U to attach additional accessories; stainless steel; dimensions side rail: 28.6 mm x 9.5 mm	1260421
	Support rod H realizes a patient weight of 450 kg	1232679
	Arm support table with clamp; pad integrally foamed, electrically conductive and soft; stainless steel load-bearing structure; dimensions (LxW): 650 mm x 260 mm	4544772
	Holding device for upper arm support to attach to side rails; used in combination with upper arm pads or pad rolls to position and provide support during surgical interventions involving the upper arm, elbow and forearm; transversal adjustment on side rail; stainless steel; height adjustment: 210 mm	1302539
	Upper arm pad short with clamp; to attach to 1302539 holding device for upper arm support; transversal shift on side rail; can be set up on both sides; radiolucent; pad integrally foamed, electrically conductive, soft and detachable; stainless steel load-bearing structure; dimensions (LxW): 215 mm x 100 mm	1322666
	Upper arm pad with clamp; to attach to 1302539 holding device for upper arm support; transversal shift on side rail; can be set up on both sides; radiolucent; pad integrally foamed, electrically conductive, soft and detachable; stainless steel load-bearing structure; dimensions (LxW): 210 mm x 230 mm	1297244

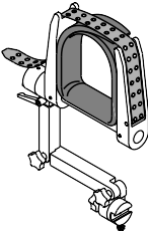
	Description	Material-No
	<p>Pad roll 80 for upper arm support with clamp; to attach to 1302539 holding device for upper arm support; transversal shift on side rail; can be set up on both sides; radiolucent; pad integrally foamed, electrically conductive, soft and detachable; stainless steel load-bearing structure; length: 270 mm diameter: 80 mm</p>	<p>1297245</p>
	<p>Traction device for humerus without clamp; adjustable to arm length; stainless steel</p>	<p>4544766</p>
	<p>Counter traction for humerus without clamp; clamp provides adjustment of height to match humerus length; padded and radiolucent; stainless steel load-bearing structure</p>	<p>4544765</p>
	<p>WEINBERGER hand traction device with clamp; to attach to 4544766 traction device for humerus and 1574736 spindle traction mechanism</p>	<p>1218836</p>
	<p>Axilla support with clamp; pad integrally foamed, electrically conductive and soft; stainless steel load-bearing structure</p>	<p>1218848</p>
	<p>Elbow support with clamp; swivel-mounted and adjustable to arm length; pad integrally foamed and electrically conductive; stainless steel load-bearing structure</p>	<p>1218847</p>

	Description	Material-No
	<p>Meniscus positioning device without clamp; height adjustable; radiolucent; pad integrally foamed, electrically conductive, soft and detachable; stainless steel load-bearing structure</p>	<p>4544791</p>
	<p>Arthroscopy positioning device basic without clamp; height adjustable; adjustable to leg width; pad integrally foamed, electrically conductive and soft; stainless steel load-bearing structure; height adjustment: 460 mm width adjustment: 110 mm - 180 mm</p>	<p>4544534</p>
	<p>Arthroscopy positioning device with clamp; for easy and exact leg positioning and secure leg fixation; tightening strap with foam padding (by OPT)</p>	<p>4544664</p>

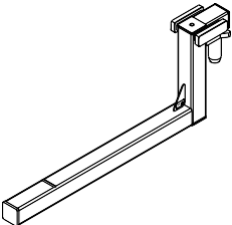
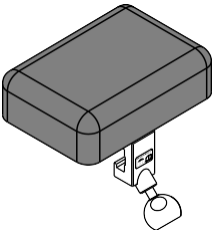
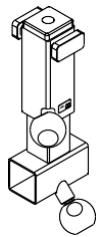
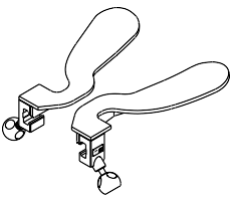
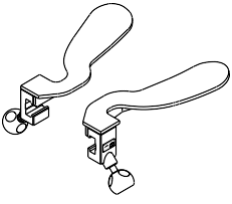
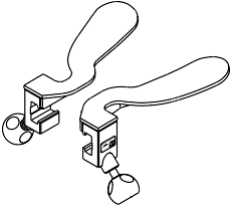
6.2 Plaster Accessories

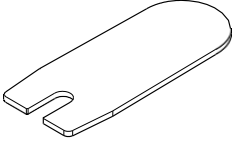
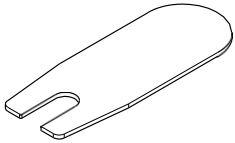
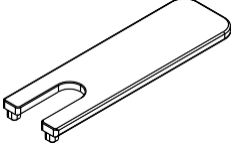
	Description	Material-No
	<p>Pelvis support to attach to Trumpf Medical OR-adapters and Universal supports; used to position patients during plastering procedures; stainless steel; dimensions (WxH): 40 mm x 40 mm</p>	<p>1386130</p>
	<p>Pad for spinal cord to attach to 1386130 pelvis support; provides additional patient support; Comfort Plus pad integrally foamed, electrically conductive, soft and detachable; stainless steel load-bearing structure; pad (LxWxH): 170 mm x 120 mm x 50 mm</p>	<p>1386131</p>
	<p>Adapter for plaster board to attach to 1386130 pelvis support; side rails on both sides; stainless steel; height adjustment: above pad level: 15 mm below pad level: - 90 mm dimensions (WxH): 40 mm x 40 mm</p>	<p>1386129</p>
	<p>Plaster board large pair to attach to 1386129 adapter for plaster board; for use on adults; stainless steel; dimensions (LxW): 280 mm x 175 mm</p>	<p>1385776</p>
	<p>Plaster board medium pair to attach to 1386129 adapter for plaster board; for use on teenagers; stainless steel; dimensions (LxW): 180 mm x 165 mm</p>	<p>1385777</p>
	<p>Plaster board small pair to attach to 1386129 adapter for plaster board; for use on infants; stainless steel; dimensions (LxW): 160 mm x 130 mm</p>	<p>1386128</p>

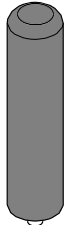
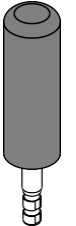
	Description	Material-No
	<p>Plaster board large to attach to 1386130 pelvis support and 1386129 adapter for plaster board; stainless steel; dimensions (LxW): 198 mm x 80 mm</p>	<p>4544458</p>
	<p>Plaster board small to attach to 1386130 pelvis support and 1386129 adapter for plaster board; stainless steel; dimensions (LxW): 160 mm x 60 mm</p>	<p>4544459</p>
	<p>Plaster board paediatrics to attach to 1386129 adapter for plaster board; for use on infants; stainless steel; dimensions (LxW): 135 mm x 40 mm</p>	<p>1474544</p>
	<p>Counter traction post to attach to 1386129 adapter for plaster board and adapters counter traction post; pad integrally foamed, electrically conductive, soft and detachable; radiolucent rod; diameter: 80 mm length: 270 mm</p>	<p>1218835</p>
	<p>Counter traction post 60 to attach to 1386129 adapter for plaster board and adapters counter traction post; pad integrally foamed, electrically conductive, soft and detachable; radiolucent rod; diameter: 60 mm length: 270 mm</p>	<p>4544453</p>
	<p>Counter traction post 80 to attach to 1386129 adapter for plaster board, OR-adapters and universal supports; pad integrally foamed, electrically conductive, soft and detachable; radiolucent rod; diameter: 80 mm length: 350 mm</p>	<p>4544449</p>

	Description	Material-No
	<p>Counter traction post plaster to attach to 1386129 adapter for plaster board; stainless steel; diameter: 16 mm length: 235 mm</p>	<p>1386629</p>

7 Extension

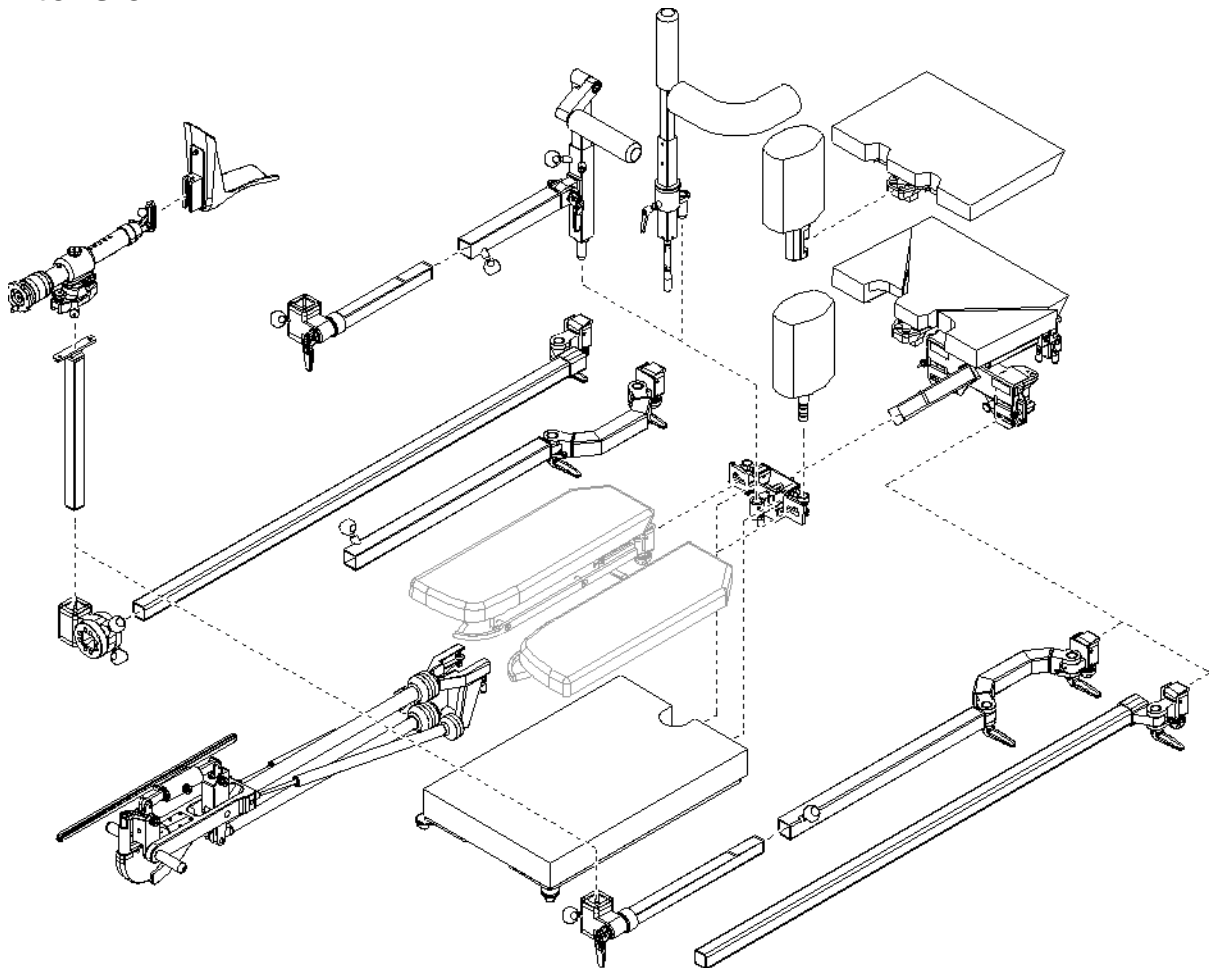

Extension

please choose the following products:

- Docking trolley
- Extension adapter depending on your OR table
- Universal support
- Supporting pad, Additional pad if necessary
- Counter traction post
- Transfer leg section
- MIS-Hip-Aggregat
- Extension and/ or Double joint strut
- Adapter Extension strut
- Extension strut
- Adapter spindle traction mechanism
- Spindle traction mechanism
- Counter traction post for tibia/ femur
- Adapter for counter traction post
- Extensions shoe

7.1 Extension - New Generation

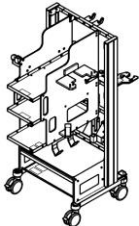
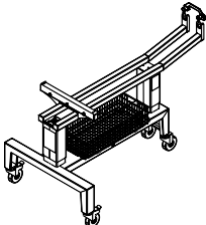
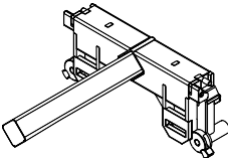
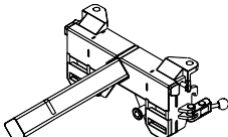
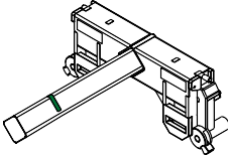
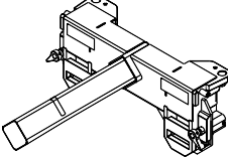
	Description	Material-No
	<p>Equip.trolley compact-cart OPT extension for positioning and transporting of the extension accessories; made of aluminum; dimensions (LxWxH): 1020 mm x 750 mm x 1700 mm (By ITD)</p>	<p>2067678</p>
	<p>Docking trolley extension unit supports transport and storage, docking and undocking of the Trumpf Medical extension unit to OR table tops on system table columns as well as docking to TruSystem 7000 and MARS; made of stainless steel</p>	<p>1867129</p>
	<p>Extension adapter adapter for table tops of the TruSystem 7500; for the adaptation of extension accessories; carbon and stainless steel load-bearing structure</p>	<p>1574666</p>
	<p>Extension adapter TS7000 adapter for operating table TruSystem 7000; to receive the extension components; carbon and stainless steel load-bearing structure</p>	<p>1850992</p>
	<p>Extension adapter TITAN adapter for operating table TITAN; for the adaptation of extension accessories; carbon and stainless steel load-bearing structure</p>	<p>1663911</p>
	<p>Extension adapter MARS adapter for operating table MARS; for the adaptation of extension accessories; carbon and stainless steel load-bearing structure</p>	<p>1706862</p>

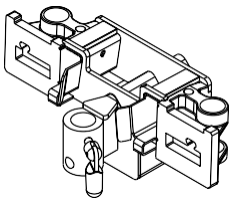
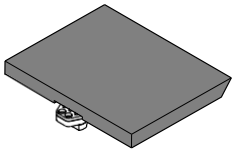
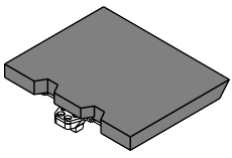
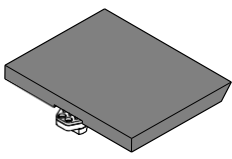
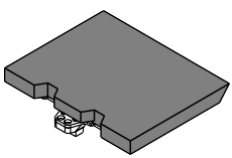
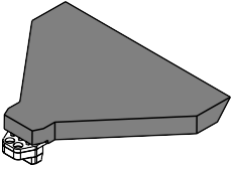
	Description	Material-No
	Universal support to slide on Extension adapters; without joint; connects leg sections, transfer leg section 1876708, counter traction posts and MIS Hip device to the OR table; fixed joints; made of stainless steel	1876707
	Supporting pad hip square pad for extension adapter 1574666 and extension adapter TITAN 1663911, soft and detachable	1593965
	Supporting pad hip B pad for extension adapter 1574666, extension adapter TITAN 1663911 an extension adapter TS7000 1850992; viscous elastic Balanced pads used for decubitus prophylaxis, electrically conductive, soft and detachable, with Velcro strap	1880218
	Supporting pad hip MARS square pad for Extension adapter MARS 1706862 integrally foamed, soft and detachable	1706914
	Supporting pad hip MARS B square pad for Extension adapter MARS 1706862 with viscous elastic Balanced pad used for decubitus prophylaxis, electrically conductive, soft and detachable, with Velcro strap	1897604
	Supporting pad universal pad for extension adapter 1574666 and extension adapter TITAN 1663911; soft and detachable	1574668

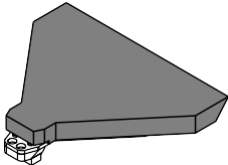
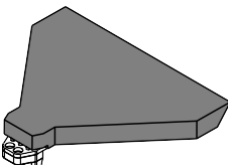
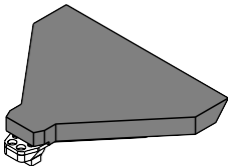
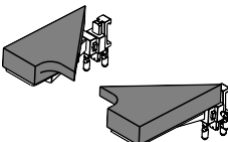
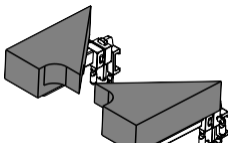
	Description	Material-No
	<p>Supporting pad universal B pad for extension adapter 1574666, extension adapter TITAN 1663911 and extension adapter TS7000 1850992; viscous elastic Balanced pads used for decubitus prophylaxis, electrically conductive, soft and detachable, with Velcro strap</p>	<p>1880217</p>
	<p>Supporting pad universal MARS pad for Extension adapter MARS 1706862 integrally foamed, soft and detachable</p>	<p>1706911</p>
	<p>Supporting pad universal MARS B pad for Extension adapter MARS 1706862; viscous elastic Balanced pad used for decubitus prophylaxis, electrically conductive, soft and detachable, with Velcro strap</p>	<p>1897603</p>
	<p>Additional pad II pair to attach to Trumpf Medical coupling point system; used with supporting pads universal; to extend the operating table top; Comfort Plus pad integrally foamed, soft and detachable; Velcro strap; stainless steel load-bearing structure</p>	<p>1594041</p>
	<p>Extension pad B to attach to Trumpf Medical coupling point system; used with supporting pad universal B; to extend the operating table top; viscous elastic Balanced pad used for decubitus prophylaxis, electrically conductive, soft and detachable, with Velcro strap; stainless steel load-bearing structure</p>	<p>1902847</p>
	<p>Angle pad TS7000 B to attach to Trumpf Medical hook coupling points; used in combination with Supporting pad universal B 1880217 to extend the operating table top; viscous elastic Balanced pads used for decubitus prophylaxis, electrically conductive, soft and detachable, with Velcro strap; stainless steel load-bearing structure</p>	<p>1886332</p>

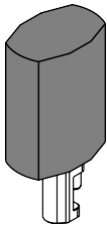
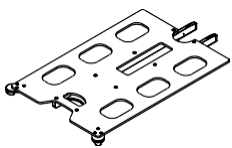
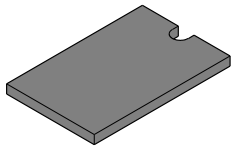
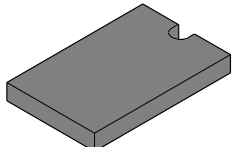
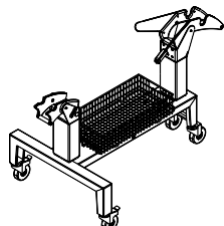
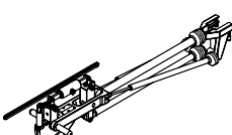
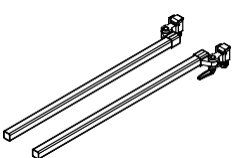
	Description	Material-No
	<p>Counter traction post X-RAY to attach to supporting pad universal or supporting pad hip; 360° radiolucent; pad electrically conductive, soft and detachable; diameter: 180 mm length: 350 mm</p>	<p>1574731</p>
	<p>Transfer leg section To attach to universal support 1876707, pad fixation with Velcro strap Dimensions: 886 mm x 542 mm x 68 mm</p>	<p>1876708</p>
	<p>Pad Transfer Leg section integrally foamed pad with Velcro strap; as initial equipment for Transfer leg section</p>	<p>1891246</p>
	<p>Pad Transfer Leg section B viscous elastic Balanced pad for decubitus prophylaxis, with Velcro strap; as initial equipment for Transfer leg section</p>	<p>1880219</p>
	<p>Docking trolley MIS hip device supports docking / undocking, transport and storage of the MIS hip device; usable for system tables and TruSystem 7000 and MARS; made of stainless steel</p>	<p>1867128</p>
	<p>MIS-Hip-Aggregat to attach to the universal supports; gas spring supported adduction and abduction; manual height adaptation; with admission rail for mounting the spindle traction mechanism 1574736</p>	<p>1574732</p>
	<p>Extension joint strut X-RAY, pair to attach to Trumpf Medical coupling point system and extension adapters; made of carbon fiber</p>	<p>1574735</p>

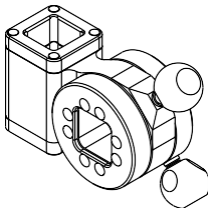
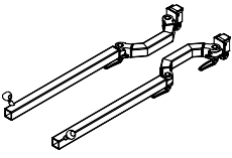
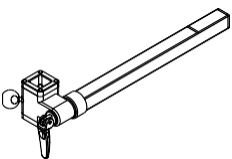
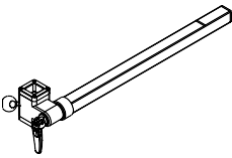
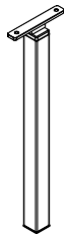
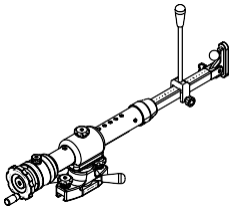
	Description	Material-No
	<p>Adapter extension strut X-RAY to slip to the extension strut X-RAY, pair 1574735; for mounting the adapter spindle traction mechanism 1593159</p>	<p>1593158</p>
	<p>Double joint strut, pair to attach to Trumpf Medical coupling point system and extension adapters; stainless steel</p>	<p>1574734</p>
	<p>Extension strut medium to attach to double joint strut, pair 1574734 or 454466; for mounting the adapter spindle traction mechanism 1593159; stainless steel load-bearing structure; length: 635 mm</p>	<p>1597668</p>
	<p>Extension strut long to attach to double joint strut, pair 1574734 or 454466; for mounting the adapter spindle traction mechanism 1593159; stainless steel load-bearing structure; length: 795 mm</p>	<p>1597669</p>
	<p>Adapter spindle traction mechanism for mounting the spindle traction mechanism; stainless steel</p>	<p>1593159</p>
	<p>Spindle traction mechanism FR for positioning patient's legs with the Trumpf Medical extension unit; allows a free rotation of the leg; with tiltable joint to attach traction boots; ball joint adjustment allows various positions; adjustment of traction by handwheel; flexible adjustment to individual length of patient's legs</p>	<p>1881967</p>

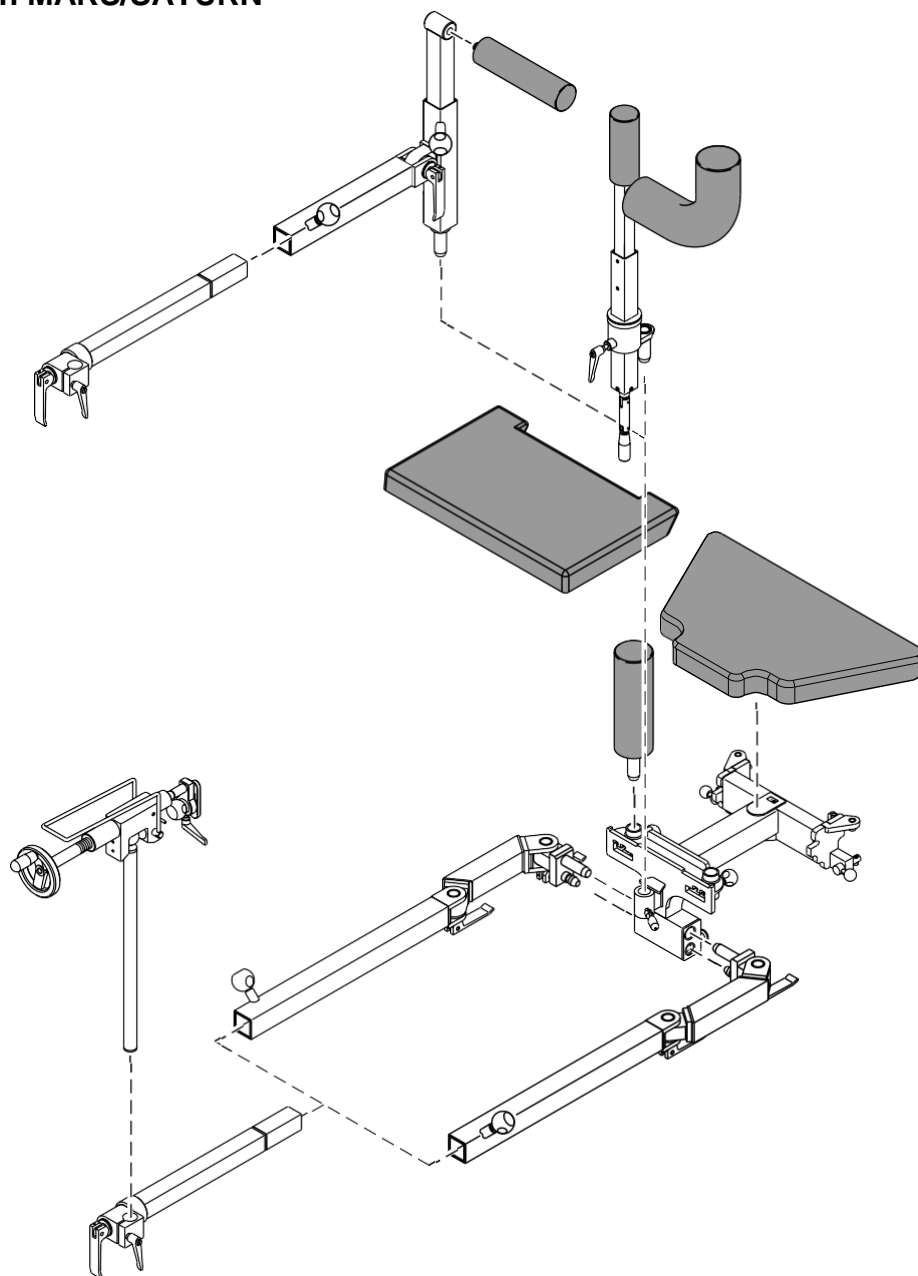

7.2 Extension MARS/SATURN



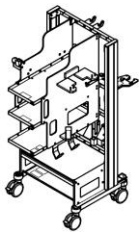
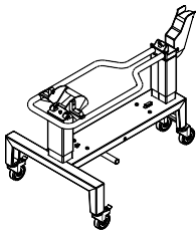
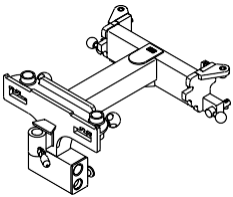
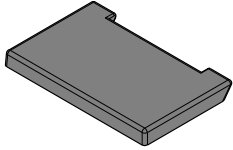
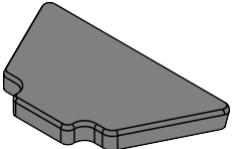
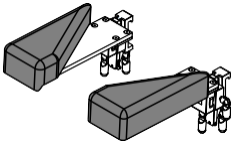

please choose the following products:

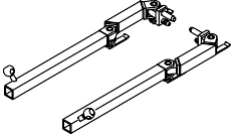
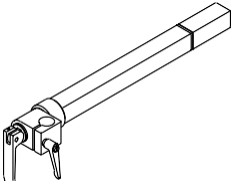
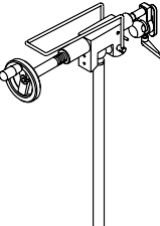
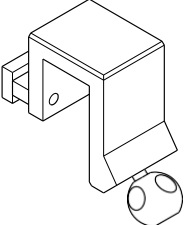

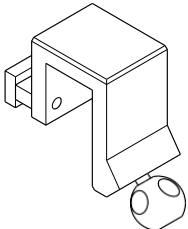
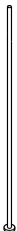
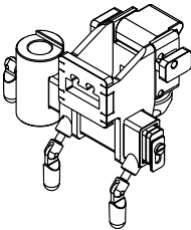
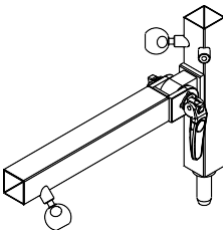
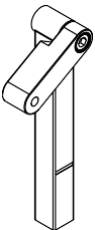

- Extension trolley
- OR-adapter
- Supporting pad, Additional pad if necessary
- Counter traction post
- Double joint strut
- Extension strut
- Adapter spindle traction mechanism
- Spindle traction mechanism
- Extensions shoe

	Description	Material-No
	<p>Equip.trolley compact-cart OPT extension for positioning and transporting of the extension accessories; made of aluminum; dimensions (LxWxH): 1020 mm x 750 mm x 1700 mm (By ITD)</p>	<p>2067678</p>
	<p>Extension trolley universal for positioning and transporting OR-adapters including accessories; with columns (except: SATURN SM) and during shuttle use as well as MARS 2.01 - 2.06, TITAN and SATURN Select; stainless steel</p>	<p>1504928</p>
	<p>OR-adapter SATURN Select/MARS II for operating tables SATURN Select 3.02, 3.03, 3.05 and 3.06 as well as MARS 2.02 and higher versions; adapter for extension accessories; stainless steel</p>	<p>1402769</p>
	<p>Supporting pad hip MARS/SATURN square pad for OR-adapter integrally foamed, soft and detachable</p>	<p>1244481</p>
	<p>Supporting pad MARS/SATURN pad for OR-adapter integrally foamed, soft and detachable</p>	<p>4544381</p>
	<p>Supporting pad MARS T pad for OR-adapter; viscous elastic FoamLine pad used for decubitus prophylaxis, electrically conductive, soft and detachable, with Velcro strap</p>	<p>1504032</p>
	<p>Additional pad SATURN/ MARS II pair to attach to Trumpf Medical coupling point system; used with Supporting pad MARS/SATURN 4544381; to extend the operating table top; Comfort Plus pad integrally foamed, soft and detachable; Velcro strap; stainless steel load-bearing structure</p>	<p>1390833</p>

	Description	Material-No
	<p>Double joint strut pair to attach to Trumpf Medical coupling point system and OR-adapters; stainless steel</p>	<p>4544466</p>
	<p>Extension strut to attach to double joint strut, pair 1574734 or 454466; for mounting the spindle traction mechanism 1218832; stainless steel load-bearing structure; length: 505 mm</p>	<p>1218831</p>
	<p>Spindle traction mechanism to attach accessories; adjustable via a ball and socket joint; traction is set by means of a handwheel</p>	<p>1218832</p>
	<p>Rail clamp for extension strut to attach accessories on the extension struts; stainless steel</p>	<p>1218833</p>
	<p>Base support stainless steel</p>	<p>1218838</p>

7.3 Extension Accessories

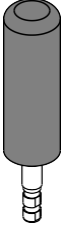
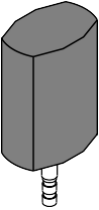
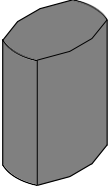

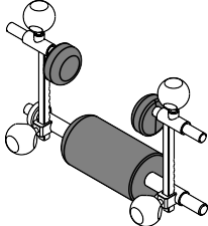
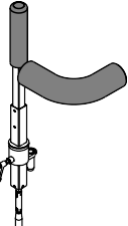
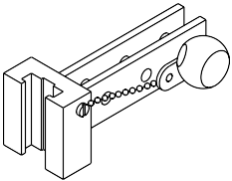
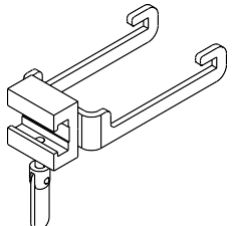
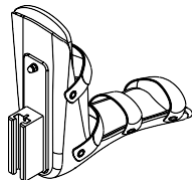
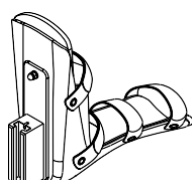

	Description	Material-No
	<p>Rail clamp for extension strut to attach accessories on the extension struts; stainless steel</p>	<p>1218833</p>
	<p>Base support stainless steel</p>	<p>1218838</p>
	<p>Universal seat OT to attach to Trumpf Medical coupling point system; for attaching the pelvis support 1386130 or the counter traction post for tibia 1576815; stainless steel</p>	<p>1576814</p>
	<p>Counter traction post for tibia to attach to the Extension unit or with the Universal seat OT 1576814 to operating table tops; stainless steel</p>	<p>1576815</p>
	<p>Adapter counter traction post pivoted to attach to the counter traction post for tibia 1576815; stainless steel</p>	<p>1576816</p>
	<p>Adapter counter traction post to attach to the counter traction post for tibia 1576815; stainless steel</p>	<p>1643382</p>

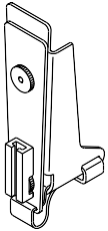
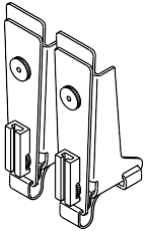
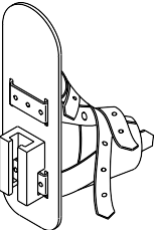
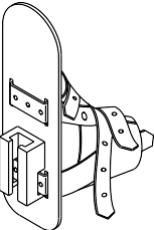
	Description	Material-No
	<p>Counter traction post to attach to 1386129 adapter for plaster board and adapters counter traction post; pad integrally foamed, electrically conductive, soft and detachable; radiolucent rod; diameter: 80 mm length: 270 m)</p>	<p>1218835</p>
	<p>Counter traction post 60 to attach to 1386129 adapter for plaster board and adapters counter traction post; pad integrally foamed, electrically conductive, soft and detachable; radiolucent rod; diameter: 60 mm length: 270 mm</p>	<p>4544453</p>
	<p>Counter traction post 80 to attach to 1386129 adapter for plaster board, OR-adapters and universal supports; pad integrally foamed, electrically conductive, soft and detachable; radiolucent rod; diameter: 80 mm length: 350 mm</p>	<p>4544449</p>
	<p>Counter traction post 150 pad electrically conductive, soft and detachable; radiolucent rod; diameter: 180 mm length: 350 mm</p>	<p>1612706</p>
	<p>Pad for counter traction post 150 pad electrically conductive, soft and detachable; diameter: 180 mm length: 250 mm</p>	<p>1612708</p>
	<p>Pad for counter traction post 220 viscous elastic pad for counter traction post; for decubitus prophylaxis; resistant to disinfectants; diameter: 220 mm length: 280 mm (by Simonsen & Weel)</p>	<p>1708619</p>



	Description	Material-No
	<p>Condylar fixation device to attach to 1576815 counter traction post for tibia in combination with 1576816 adapter counter traction post pivoted or 1643382 adapter for counter traction post; for exact knee positioning; pad integrally foamed, electrically conductive, soft and detachable; stainless steel load-bearing structure; height adjustment: 125 mm</p>	<p>1434382</p>
	<p>Counter traction post for femur for interventions in lateral position; counter traction post and perineal bow with integrally foamed and soft pad; height adjustable via crank; stainless steel load-bearing structure; height adjustment: 125 mm</p>	<p>4544448</p>
	<p>Adapter for KIRSCHNER bow stainless steel</p>	<p>1218837</p>
	<p>Adapter for KIRSCHNER BOW basic stainless steel</p>	<p>4544784</p>
	<p>Traction boot for adults</p>	<p>1574733</p>
	<p>Traction boot children for children</p>	<p>1610541</p>

	Description	Material-No
	<p>Plastic extension shoe for adults</p>	<p>1217672</p>
	<p>Plastic extension shoes for kids, pair for children</p>	<p>1218863</p>
	<p>Leather extension sandal right to attach to spindle traction mechanism</p>	<p>1232546</p>
	<p>Leather extension sandal left to attach to spindle traction mechanism</p>	<p>4544790</p>

8 Pediatric Surgery

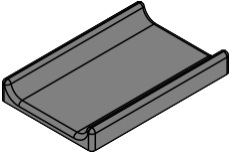
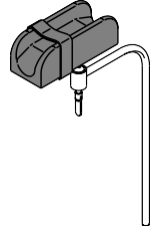
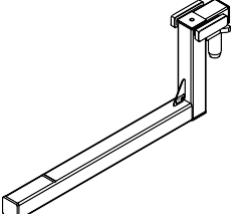
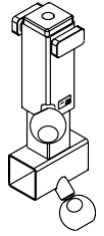
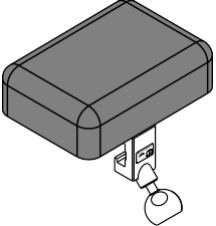
	Description	Material-No
	Head ring Paediatrics viscous elastic pad for positioning the patient's head in supine or prone position; used for paediatrics; pad for decubitus prophylaxis; resistant to disinfectants; diameter: 90/ 45 mm height: 20 mm colour: pink (by Simonsen & Weel)	1708610
	Pad for head positioning Paediatrics viscous elastic pad for positioning the patient's head in supine or prone position; used for paediatrics; pad for decubitus prophylaxis; resistant to disinfectants; dimensions (LxWxH): 300 mm x 200 mm x 70 mm colour: pink (by Simonsen & Weel)	1708608
	Wedge Paediatrics viscous elastic pad in V-formation; used for paediatrics; pad for decubitus prophylaxis; resistant to disinfectants; dimensions (LxWxH): 150 mm x 280 mm x 60 mm colour: pink (par Simonsen & Weel)	1708582
	Cushion for sternum support Paediatrics viscous elastic pad for supporting the patient's thorax in prone position; used for paediatrics; pad for decubitus prophylaxis; resistant to disinfectants; dimensions (LxWxH): 250 mm x 90 mm x 60 mm colour: pink (by Simonsen & Weel)	1708606
	Pad semi circular shaped Paediatrics viscous elastic, semi circular shaped pad for positioning of the knee in supine position; used for paediatrics; pad for decubitus prophylaxis; resistant to disinfectants; dimensions (LxWxH): 300 mm x 50 mm x 50 mm colour: pink (by Simonsen & Weel)	1708575

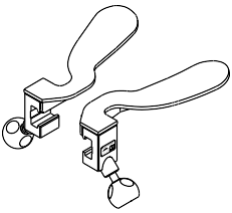
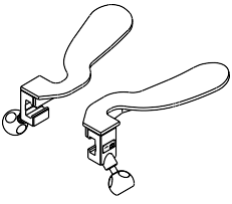
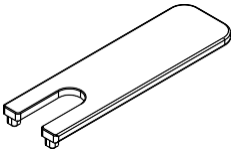
	Description	Material-No
	<p>Heel pad Paediatrics</p> <p>viscous elastic pad for positioning of the legs and the heels in supine position; used for paediatrics; pad for decubitus prophylaxis; resistant to disinfectants; dimensions (LxWxH): 380 mm x 180 mm x 110/ 70 mm colour: pink (by Simonsen & Weel)</p>	<p>1708581</p>
	<p>Special shaped cushion Paediatrics</p> <p>to attach to extension section paediatrics via Velcro strap; for safe and stable patient positioning; pad is electrically conductive and soft; dimensions (LxWxH): 610 mm x 402 mm x 80 mm</p>	<p>1364284</p>
	<p>Leg holder GOEPEL for children</p> <p>without clamp; pad integrally foamed, electrically conductive and soft; stainless steel load-bearing structure</p>	<p>4544789</p>
	<p>Pelvis support</p> <p>to attach to Trumpf Medical OR-adapters and Universal supports; used to position patients during plastering procedures; stainless steel; dimensions (WxH): 40 mm x 40 mm)</p>	<p>1386130</p>
	<p>Adapter for plaster board</p> <p>to attach to 1386130 pelvis support; side rails on both sides; stainless steel; height adjustment: above pad level: 15 mm below pad level: - 90 mm) dimensions (WxH): 40 mm x 40 mm)</p>	<p>1386129</p>
	<p>Pad for spinal cord</p> <p>to attach to 1386130 pelvis support; provides additional patient support; Comfort Plus pad integrally foamed, electrically conductive, soft and detachable; stainless steel load-bearing structure; pad (LxWxH): 170 mm x 120 mm x 50 mm)</p>	<p>1386131</p>



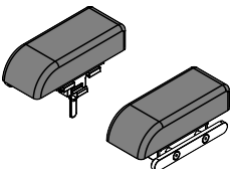
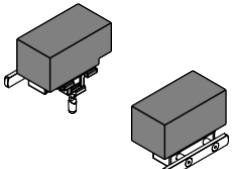
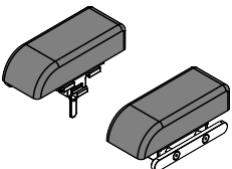
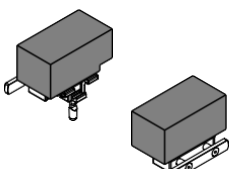
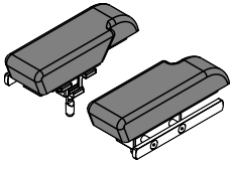

	Description	Material-No
	Plaster board small pair to attach to 1386129 adapter for plaster board; for use on infants; stainless steel; dimensions (LxW): 160 mm x 130 mm)	1386128
	Plaster board medium pair to attach to 1386129 adapter for plaster board; for use on teenagers; stainless steel; dimensions (LxW): 180 mm x 165 mm	1385777
	Plaster board paediatrics to attach to 1386129 adapter for plaster board; for use on infants; stainless steel; dimensions (LxW): 135 mm x 40 mm	1474544
	Counter traction post plaster to attach to 1386129 adapter for plaster board; stainless steel; diameter: 16 mm) length : 235 mm	1386629

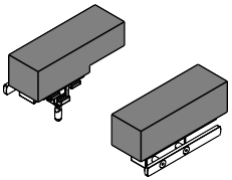
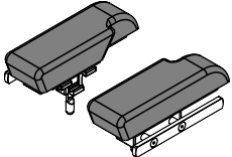
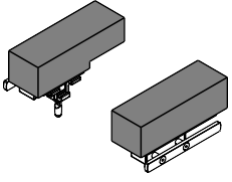
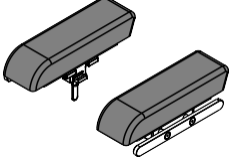
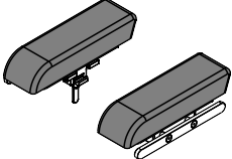

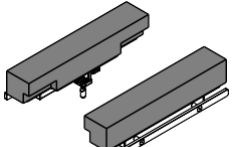
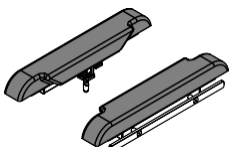
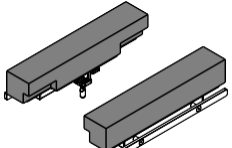
9 Bariatric Surgery

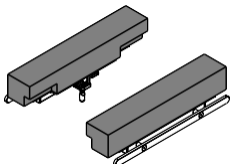
	Description	Material-No
	<p>Widening segment UBS</p> <p>with clamp; to attach to side rail (25 mm x 10 mm) of upper back section; extends table top width; Comfort Plus pads integrally foamed, electrically conductive, soft and detachable; stainless steel load-bearing structure; dimensions (LxW): 190 mm x 125 mm dimensions side rail: 25 mm x 10 mm</p>	1505912
	<p>Widening segment UBS T</p> <p>with clamp; to attach to side rail (25 mm x 10 mm) of upper back section; extends table top width; viscous elastic Balanced pads used for decubitus prophylaxis, electrically conductive, soft and detachable, with Velcro strap; stainless steel load-bearing structure; dimensions (LxW): 190 mm x 125 mm dimensions side rail: 25 mm x 10 mm</p>	1505915
	<p>Widening segment UBS U</p> <p>with clamp; to attach to side rail (28.6 mm x 9.5 mm) of upper back section; extends table top width; Comfort Plus pads integrally foamed, electrically conductive, soft and detachable; stainless steel load-bearing structure; dimensions (LxW): 190 mm x 125 mm dimensions side rail: 28.6 mm x 9.5 mm</p>	1505916
	<p>Widening segment UBS U T</p> <p>with clamp; to attach to side rail (28.6 mm x 9.5 mm) of upper back section; extends table top width; viscous elastic Balanced pads used for decubitus prophylaxis, electrically conductive, soft and detachable, with Velcro strap; stainless steel load-bearing structure; dimensions (LxW): 190 mm x 125 mm dimensions side rail: 28.6 mm x 9.5 mm</p>	1505918
	<p>Widening segment back section TruSystem</p> <p>with clamp; to attach to side rails (25 mm x 10 mm) of back section for TruSystem 7500 and 5500; extends table top width; Comfort Plus pads integrally foamed, electrically conductive, soft and detachable; stainless steel load-bearing structure; dimensions (LxW): 320 mm x 125 mm dimensions side rail: 25 mm x 10 mm</p>	1505904

	Description	Material-No
	<p>Widening segment back sec. TruSystem T</p> <p>with clamp; to attach to side rails (25 mm x 10 mm) of back section for TruSystem 7500 and 5500; extends table top width; viscous elastic Balanced pads used for decubitus prophylaxis, electrically conductive, soft and detachable, with Velcro strap; stainless steel load-bearing structure; dimensions (LxW): 320 mm x 125 mm dimensions side rail: 25 mm x 10 mm</p>	<p>1505907</p>
	<p>Widening segment back sec. TruSystem U</p> <p>with clamp; to attach to side rails (28.6 mm x 9.5 mm) of back section for TruSystem 7500 and 5500; extends table top width; Comfort Plus pads integrally foamed, electrically conductive, soft and detachable; stainless steel load-bearing structure; dimensions (LxW): 320 mm x 125 mm dimensions side rail: 28.6 mm x 9.5 mm</p>	<p>1505908</p>
	<p>Widening segment back sec. TruSystem U T</p> <p>with clamp; to attach to side rails (28.6 mm x 9.5 mm) of back section for TruSystem 7500 and 5500; extends table top width; viscous elastic Balanced pads used for decubitus prophylaxis, electrically conductive, soft and detachable, with Velcro strap; stainless steel load-bearing structure; dimensions (LxW): 320 mm x 125 mm dimensions side rail: 28.6 mm x 9.5 mm</p>	<p>1505910</p>
	<p>Widening segment back section J/M</p> <p>with clamp; to attach to side rails (25 mm x 10 mm) of back section for operating tables JUPITER and MARS; extends table top width; Comfort Plus pads integrally foamed, electrically conductive, soft and detachable; stainless steel load-bearing structure; dimensions (LxW): 340 mm x 125 mm dimensions side rail: 25 mm x 10 mm</p>	<p>1247479</p>
	<p>Widening segment back section J/M U</p> <p>with clamp; to attach to side rails (28.6 mm x 9.5 mm) of back section for operating tables JUPITER and MARS; extends table top width; Comfort Plus pads integrally foamed, electrically conductive, soft and detachable; stainless steel load-bearing structure; dimensions (LxW): 340 mm x 125 mm dimensions side rail: 128.6 mm x 9.5 mm</p>	<p>1255811</p>

	Description	Material-No
	<p>Widening segment back section SATURN</p> <p>with clamp; to attach to side rails (25 mm x 10 mm)) of back section for operating tables SATURN; extends table top width; Comfort Plus pads integrally foamed, electrically conductive, soft and detachable; stainless steel load-bearing structure; dimensions (LxW): 505 mm x 125 mm dimensions side rail: 25 mm x 10 mm</p>	<p>1251179</p>
	<p>Widening segment seat section TS/S/M</p> <p>with clamp; to attach to side rails (25 mm x 10 mm) of seat section of operating tables TruSystem 7500 and 5500, SATURN and MARS; extends table top width; Comfort Plus pads integrally foamed, electrically conductive, soft and detachable; stainless steel load-bearing structure; dimensions (LxW): 610 mm x 125 mm dimensions side rail: 25 mm x 10 mm</p>	<p>1500067</p>
	<p>Widening segment seat section TS/M T</p> <p>with clamp; to attach to side rails (25 mm x 10 mm) of seat section of operating tables TruSystem 7500 and 5500, SATURN and MARS; extends table top width; viscous elastic Balanced pads used for decubitus prophylaxis, electrically conductive, soft and detachable, with Velcro strap; stainless steel load-bearing structure; dimensions (LxW): 610 mm x 125 mm dimensions side rail: 25 mm x 10 mm</p>	<p>1505900</p>
	<p>Widening segment seat sec. TS/M U</p> <p>with clamp; to attach to side rails (28.6 mm x 9.5 mm) of seat section of operating tables TruSystem 7500 and 5500, SATURN and MARS; extends table top width; Comfort Plus pads integrally foamed, electrically conductive, soft and detachable; stainless steel load-bearing structure; dimensions (LxW): 610 mm x 125 mm dimensions side rail: 28.6 mm x 9.5 mm</p>	<p>1505901</p>
	<p>Widening segment seat sec. TS/M U T</p> <p>with clamp; to attach to side rails (28.6 mm x 9.5 mm) of seat section of operating tables TruSystem 7500 and 5500, SATURN and MARS; extends table top width; viscous elastic Balanced pads used for decubitus prophylaxis, electrically conductive, soft and detachable, with Velcro strap; stainless steel load-bearing structure; dimensions (LxW): (610 mm x 125 mm) dimensions side rail: (28.6 mm x 9.5 mm)</p>	<p>1505903</p>



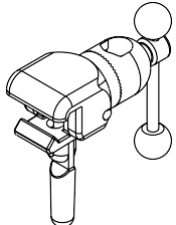
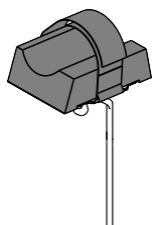

	Description	Material-No
	<p>Widening segment seat section TITAN with clamp; to attach to side rails (25 mm x 10 mm) of seat section for operating tables TruSystem 7000; extends table top width; with viscous elastic Balanced pad for decubitus prophylaxis; electrically conductive, soft and detachable, attachment via Velcro; stainless steel load-bearing structure; dimensions (LxW): 560 mm x 125 mm dimensions side rail: 25 mm x 10 mm</p> <p>Widening segment seat section TITAN U with clamp; to attach to side rails (25 mm x 10 mm) of seat section for operating tables TruSystem 7000; extends table top width; with viscous elastic Balanced pad for decubitus prophylaxis; electrically conductive, soft and detachable, attachment via Velcro; stainless steel load-bearing structure; dimensions (LxW): 560 mm x 125 mm dimensions side rail: 28.6 mm x 9.5 mm</p>	<p>1251180</p> <p>1255814</p>
	<p>Pad for lumbar spine Bariatric viscous elastic pad for supporting the lumbar spine in supine position; pad for decubitus prophylaxis; used for bariatric surgery; resistant to disinfectants; dimensions (LxWxH): 210 mm x 450 mm x 80 mm colour: grey (by Simonsen & Weel)</p>	<p>1727208</p>
	<p>Wedge Bariatric viscous elastic pad in V-formation; pad for decubitus prophylaxis; used for bariatric surgery; resistant to disinfectants; dimensions (LxWxH): 400 mm x 170 mm x 130 mm colour: grey (by Simonsen & Weel)</p>	<p>1727207</p>
	<p>Pad supine position short Bariatric viscous elastic pad for positioning of the upper body in supine position; pad for decubitus prophylaxis; used for bariatric surgery; resistant to disinfectants; dimensions (LxWxH): 650 mm x 550 mm x 210/ 25 mm colour: grey (by Simonsen & Weel)</p>	<p>1727206</p>
	<p>Pad supine position long Bariatric viscous elastic pad for positioning of the upper body in supine position; pad for decubitus prophylaxis; used for bariatric surgery; resistant to disinfectants; dimensions (LxWxH): 750 mm x 550 mm x 250/ 25 mm colour: grey (by Simonsen & Weel)</p>	<p>1727205</p>

	Description	Material-No
	<p>Pad semi circular shaped 250 Bariatric</p> <p>viscous elastic, semi circular shaped pad for positioning of the knee in supine position; pad for decubitus prophylaxis; used for bariatric surgery; resistant to disinfectants; dimensions (LxWxH): 250 mm x 200 mm x 100 mm colour: grey (by Simonsen & Weel)</p>	1727210
	<p>Pad semi circular shaped 500 Bariatric</p> <p>viscous elastic, semi circular shaped pad for positioning of the knee in supine position; pad for decubitus prophylaxis; used for bariatric surgery; resistant to disinfectants; dimensions (LxWxH): 500 mm x 200 mm x 100 mm colour: grey (by Simonsen & Weel)</p>	1727209
	<p>Leg and heel pad Bariatric</p> <p>viscous elastic pad for positioning of the legs and the heels in supine position; pad for decubitus prophylaxis; used for bariatric surgery; resistant to disinfectants; dimensions (LxWxH): 500 mm x 260 mm x 150/ 100 mm colour: grey (by Simonsen & Weel)</p>	1727231
	<p>Leg positioning pad Bariatric</p> <p>viscous elastic pad for positioning of the legs in supine position; pad for decubitus prophylaxis; used for bariatric surgery; resistant to disinfectants; dimensions (LxWxH): 650 mm x 500 mm x 140 mm colour: grey (by Simonsen & Weel)</p>	1727232
	<p>Radial setting clamp HEAVY</p> <p>version for heavy loads; to attach to side rails by frontal placement; 360° adjustment; suitable for rods of 15 mm - 20 mm diameter; stainless steel</p>	4544530
	<p>Leg holder HEAVY T</p> <p>without clamp; viscous elastic FoamLine pad used for decubitus prophylaxis, electrically conductive, soft and detachable, with Velcro strap; stainless steel frame</p>	1506318

	Description	Material-No
	<p>Belt for bariatric surgery pair pair; belt for fixation of the patient's legs in bariatric surgery; dimensions (LxWxH): 1520 mm x 425 mm x 5 mm (per belt) (by Simonsen & Weel)</p>	<p>1783309</p>

10 Positioning Devices

10.1 Positioning Pads

	Description	Material-No
	<p>Wedge flat viscous elastic pad in V-formation; pad for decubitus prophylaxis; resistant to disinfectants; dimensions (LxWxH): 350 mm x 150 mm x 80 mm colour: green (by Simonsen & Weel)</p>	<p>1708583</p>
	<p>Pad for lumbar spine viscous elastic pad for supporting the lumbar spine in supine position; pad for decubitus prophylaxis; resistant to disinfectants; dimensions (LxWxH): 210 mm x 320 mm x 55 mm colour: green (by Simonsen & Weel)</p>	<p>1708571</p>
	<p>Pad semi circular shaped 250 viscous elastic, semi circular shaped pad for positioning of the knee in supine position; pad for decubitus prophylaxis; resistant to disinfectants; dimensions (LxWxH): 250 mm x 200 mm x 100 mm colour: green (by Simonsen & Weel)</p>	<p>1708573</p>
	<p>Pad semi circular shaped 500 viscous elastic, semi circular shaped pad for positioning of the knee in supine position; pad for decubitus prophylaxis; resistant to disinfectants; dimensions (LxWxH): 500 mm x 200 mm x 100 mm colour: green (by Simonsen & Weel)</p>	<p>1708572</p>
	<p>Leg and heel pad viscous elastic pad for positioning of the legs and the heels in supine position; pad for decubitus prophylaxis; resistant to disinfectants; dimensions (LxWxH): 500 mm x 220 mm x 150/ 100 mm colour: green (by Simonsen & Weel)</p>	<p>1708580</p>
	<p>Leg positioning pad viscous elastic pad for positioning of the legs in supine position; pad for decubitus prophylaxis; resistant to disinfectants; dimensions (LxWxH): 650 mm x 500 mm x 140 mm colour: green (by Simonsen & Weel)</p>	<p>1708584</p>

	Description	Material-No
	<p>Tunnel pillow II viscous elastic pad for protecting leg from injuries in lateral position; pad for decubitus prophylaxis; resistant to disinfectants; dimensions (LxWxH): 650 mm x 400 mm x 220 mm colour: blue (by Simonsen & Weel)</p>	<p>1708600</p>
	<p>Pad for lateral position viscous elastic pad for positioning patients in lateral position; pad for decubitus prophylaxis; resistant to disinfectants; dimensions (LxWxH): 550 mm x 500 mm x 200 mm colour: blue (by Simonsen & Weel)</p>	<p>1740769</p>
	<p>Plane pad 22 viscous elastic pad for decubitus prophylaxis; resistant to disinfectants; dimensions (LxWxH): 220 mm x 170 mm x 20 mm (by Simonsen & Weel)</p>	<p>1703513</p>
	<p>Plane pad 35 viscous elastic pad for decubitus prophylaxis; resistant to disinfectants; dimensions (LxWxH): 350 mm x 300 mm x 20 mm (by Simonsen & Weel)</p>	<p>1708635</p>
	<p>Plane pad 40 viscous elastic pad for decubitus prophylaxis; resistant to disinfectants; dimensions (LxWxH): 400 mm x 250 mm x 20 mm (by Simonsen & Weel)</p>	<p>1703514</p>
	<p>Plane pad 50 BASIC viscous elastic pad for decubitus prophylaxis; resistant to disinfectants; dimensions (LxWxH): 500 mm x 300 mm x 20 mm (by Simonsen & Weel)</p>	<p>1708632</p>
	<p>Plane pad 50 viscous elastic pad for decubitus prophylaxis; resistant to disinfectants; dimensions (LxWxH): 500 mm x 300 mm x 50 mm (by Simonsen & Weel)</p>	<p>1708636</p>

10.2 Vacuum mattresses

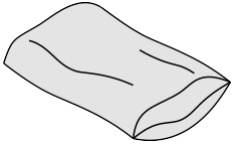
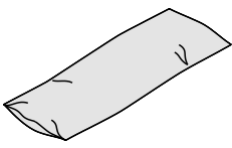
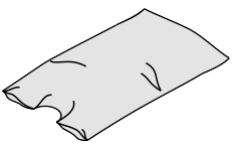
	Description	Material-No
	<p>Vacuum pump for vacuum cushions and mattresses (by B. u. W. Schmidt GmbH)</p>	1559988
	<p>Repair set for vacuum cushions to close small cracks and holes (by B. u. W. Schmidt GmbH)</p>	1559989
	<p>Vacuum cushion paediatrics dimensions (LxWxH): 400 mm x 700 mm (by B. u. W. Schmidt GmbH)</p>	1559987
	<p>Universal mattress vacuum mattress; dimensions (LxW): 1000 mm x 2000 mm (by B. u. W. Schmidt GmbH)</p>	1550656
	<p>Mattress with Uro-cut vacuum mattress; dimensions (LxW): 750 mm x 1000 mm (by B. u. W. Schmidt GmbH)</p>	1550658

10.3 Gel pads

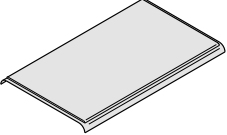
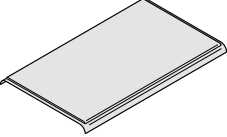
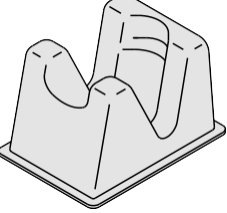
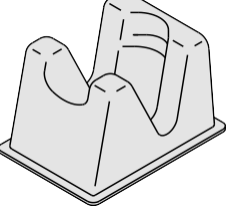
	Description	Material-No
	<p>Table gel pad large dimensions (LxWxH): 1100 mm x 500 mm x 15 mm weight: 5 kg (by Stihler Electronic GmbH)</p>	<p>1219020</p>
	<p>Table gel pad small dimensions (LxWxH): 860 mm x 370 mm x 15 mm weight: 3 kg (by Stihler Electronic GmbH)</p>	<p>1219021</p>
	<p>Pad for prone position large gel pad; dimensions (LxWxH): 280 mm x 230 mm x 145 mm (by TapMed Medizintechnik Handels GmbH)</p>	<p>1237192</p>
	<p>Pad for prone position small gel pad; dimensions (LxWxH): 230 mm x 190 mm x 130 mm (by TapMed Medizintechnik Handels GmbH)</p>	<p>1303201</p>

11 Medical furniture

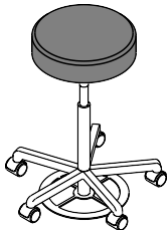
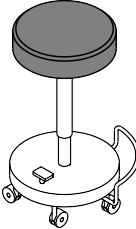
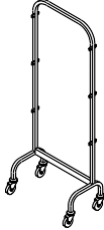
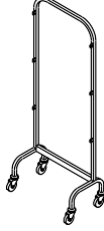
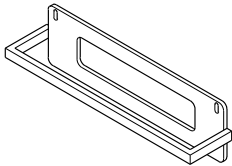
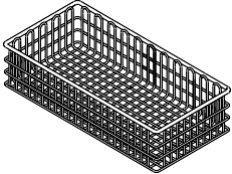
	Description	Material-No
	<p>Low revolving stool stainless steel, base made of aluminium; height adjustment: 520 mm - 690 mm (by inmoclinc)</p>	<p>2000037</p>
	<p>Mobile Swivel Stool stainless steel; height adjustment: 540 mm - 770 mm (by Joerg & Sohn GmbH)</p>	<p>2000038</p>
	<p>Bilateral hook trolley three pairs of hooks on both sides; stainless steel; dimensions (LxWxH): 600 mm x 670 mm x 1438 mm (by MedSysteme)</p>	<p>1218493</p>
	<p>Unilateral hook trolley three pairs of hooks on the front; stainless steel; dimensions (LxWxH): 600 mm x 640 mm x 1438 mm (by MedSysteme)</p>	<p>1218503</p>
	<p>Support for operating table accessories stainless steel (by MedSysteme)</p>	<p>4544725</p>
	<p>Sterilization wire mesh basket 1/2 used as depot basket; stainless steel; dimensions (LxWxH): 575 mm x 280 mm x 135 mm (by Koegel GmbH)</p>	<p>1215712</p>

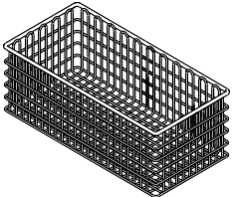
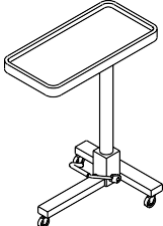
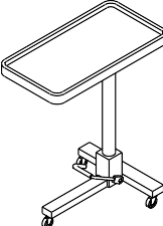
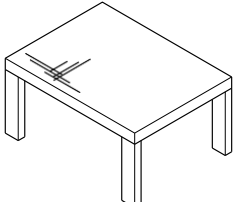
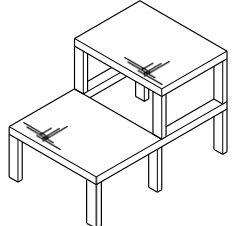
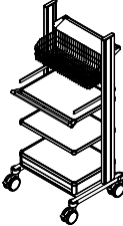
	Description	Material-No
	<p>Sterilization wire mesh basket 1/1 used as depot basket; stainless steel; dimensions (LxWxH): 575 mm x 280 mm x 265 mm (by Koegel GmbH)</p>	<p>1215760</p>
	<p>Oil pump instrument table 640 maximum load: 30 kg dimensions (LxWxH): 640 mm x 440 mm height: 950 mm - 1350 mm (by MedSysteme)</p>	<p>2066072</p>
	<p>Oil pump instrument table 740 maximum load: 30 kg dimensions (LxWxH): 740 mm x 540 mm height: 950 mm - 1350 mm (by MedSysteme)</p>	<p>2066073</p>
	<p>Surgeon's mounting step 300 detachable step surface; dimensions (LxWxH): 600 mm x 350 mm x 300 mm ((by MedSysteme)</p>	<p>2066074</p>
	<p>Surgeon's double mounting step 220/440 detachable step surface; dimensions (LxWxH): 600 mm x 650 mm x 220mm/ 440 mm) (by MedSysteme)</p>	<p>1218784</p>
	<p>Trolley OPT accessories Trolley ITD compact-cart OPT accessories Trolley equipped with: - 3 platforms - 2 norm rails - 1 basket - 1 holding frame - 1 drawer - 1 control handle (by ITD)</p>	<p>2067670</p>

